



# ARCHITECTURAL WINDOWS AND DOORS

## **CITYVIEW™ 101.6mm SLIDING WINDOW**

101.6mm Sliding Window Sections.....	39
Sliding Window Hardware.....	47
System Tooling .....	51

## **CITYVIEW™ 101.6mm DOUBLE HUNG WINDOW**

101.6mm Double Hung Window Sections .....	53
Double Hung Window Hardware .....	58
System Tooling .....	60

## **CITYVIEW™ AWNING & CASEMENT WINDOW**

Awning & Casement Window Sections.....	63
Truth / Awning Window Sections .....	66
Awning Window Hardware .....	67

## **HARBOUR™VIEW MULTIFOLD DOOR SYSTEM**

Standard Flushbolt Multifold Door .....	75
Brio Flushbolt Multifold Door .....	77
Bottom Rolling Multifold Door .....	78
Single Glazed Multifold Door .....	79
Double Glazed Multifold Door .....	80
Top Rolling Multifold Door Hardware.....	81
Bottom Rolling Multifold Door Hardware .....	82
Multifold Door Hardware .....	83
System Tooling .....	92

## **CITYVIEW™ PATIO DOOR SYSTEM**

101.6mm Patio Door.....	95
165mm Patio Door.....	98
Patio Door Sections.....	99
Patio Door Sections - Single Piece.....	103
Patio Door Hardware.....	104
System Tooling .....	109

## **CITYVIEW™ APARTMENT DOOR SYSTEM**

101.6mm Apartment Door.....	111
150mm Apartment Door.....	117
203.6mm Apartment Door.....	121
Apartment Door Sections.....	122
Apartment Door Sections - High Performance .....	126
Apartment Door Hardware.....	127

**DOOR SECTIONS**

35mm Door Sections .....	133
45mm Door Sections - Standard .....	134
45mm Door Sections - Open Pocket.....	137
45mm Door Sections - Open Pocket Double Glazed .....	139
45mm Door Sections - Flush Face.....	141
45mm Door Sections - Double Beaded Door .....	142
Commercial Door Tracks.....	144
Door Section Hardware.....	146
Hinges.....	147
Door Closers .....	149
Locks - Commercial.....	150
Door Section Hardware.....	155
System Tooling .....	157

**LOUVRE WINDOWS**

Manually Operated Louvre Windows .....	159
Motorised Louvre Windows.....	164
Cityview™ 101.6mm Louvre System .....	167

**KLASSICVIEW™ RESIDENTIAL WINDOW & DOOR SYSTEMS**

Residential Window & Door Systems .....	170
Complete Knocked-Down-Kits (KDK) .....	171

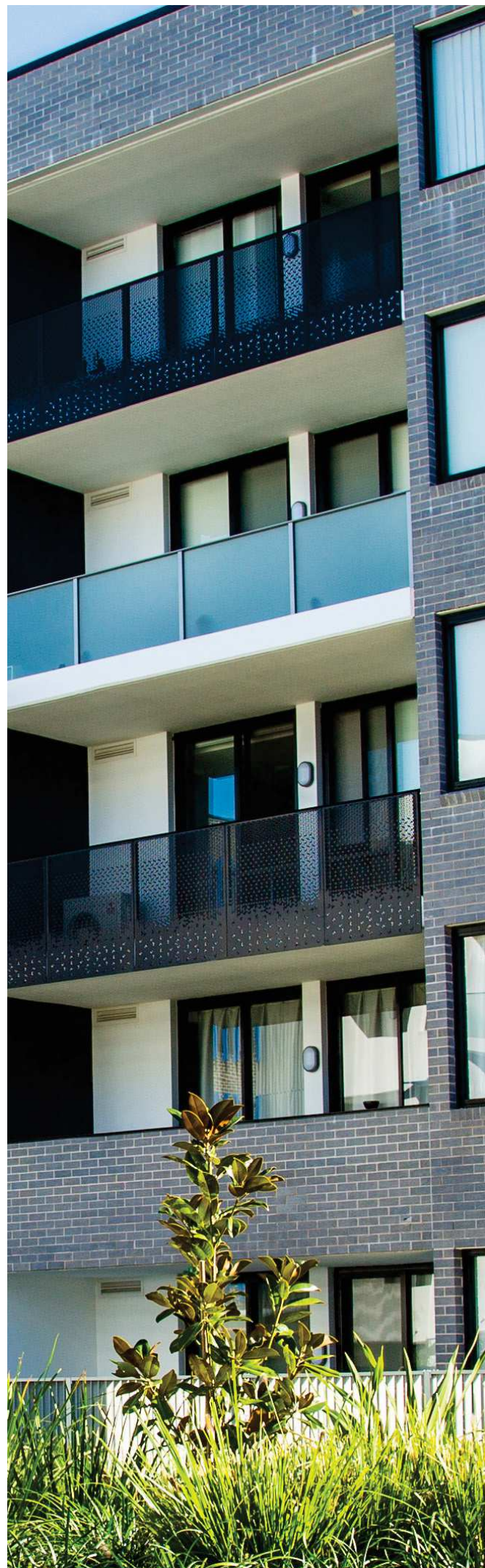



**101.6mm SLIDING WINDOW**

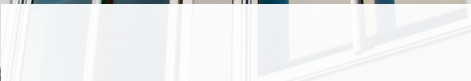

101.6MM SLIDING WINDOW PATIO DOOR (INCLUDING SINGLE PIECE INTERLOCK)		
GLASS THICKNESS	CHANNEL RUBBER REQUIRED	POCKET SIZE
6mm	1670	12.5mm
8mm	1604	
10mm	1671	
12mm	1666	21.5mm
16mm	1689	
18mm	1667	
20mm	1677	
20.4mm	1661	



1604



1661



1666



1670



1667



1671









1677

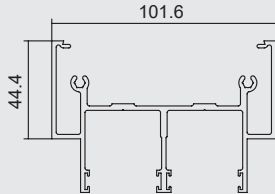

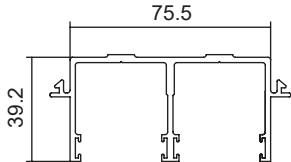

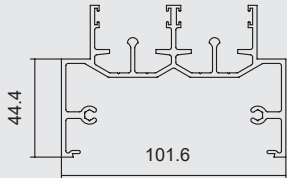

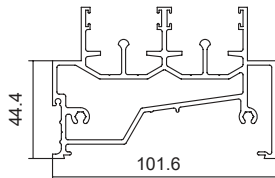
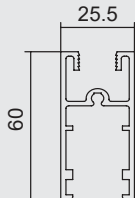

1689

# 101.6MM SLIDING WINDOW SECTIONS

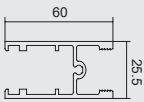
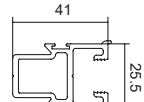
CODE	DESCRIPTION	LGTH	FINISH	GROUP ID	
SW001	Head  1721	5.3m	M/F CL/ANOD	10601 10602	
SW002	Snap In Head Fits with TJ302  1721	5.3m	M/F CL/ANOD	10601 10602	
SW003	Open Sill  1721	5.3m	M/F CL/ANOD	10601 10602	
SW004	Closed Sill (Slotted) Fits with TJ304  1721, 1685	5.3m	M/F CL/ANOD	10601 10602	
SW007	Single Glazed Rail	5.3m	M/F CL/ANOD	10601 10602	

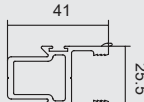

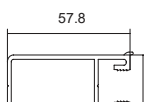
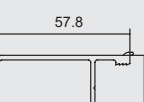
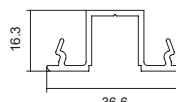
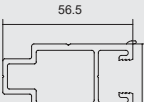
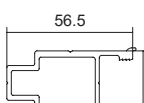
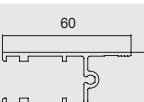
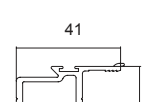

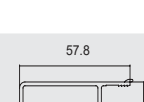
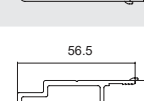





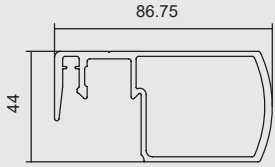

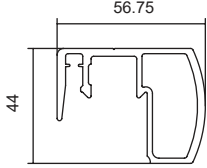
 Key hardware.

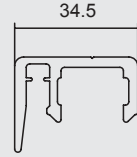
# 101.6MM SLIDING WINDOW SECTIONS

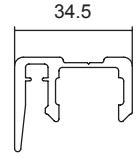
	CODE	DESCRIPTION		LGTH.	FINISH	GROUP ID
	SW008	Double Glazed Rail Suits 16mm Glass	<b>TO BE DISCONTINUED</b>	5.3m	M/F CL/ANOD	10601 10602
	SW009	Single Glazed Interlock Stile Fits with SW014/015/016  1721		4.6m 5.4m	M/F CL/ANOD	10601 10602
	SW010	Double Glazed Interlock Stile Suits 16mm Fits with SW014/015/016  1721	<b>TO BE DISCONTINUED</b>	4.6m 5.4m	M/F CL/ANOD	10601 10602
	SW011	Single Glazed Lock Stile		4.6m 5.4m	M/F CL/ANOD	10601 10602
	SW012	Double Glazed Lock Stile Suits 16mm Glass	<b>TO BE DISCONTINUED</b>	4.6m 5.4m	M/F CL/ANOD	10601 10602
	SW020	Flyscreen Adaptor Fits with SW018		4.6m	M/F CL/ANOD	10601 10602
	SW022	Single Glazed Male Stile	<b>TO BE DISCONTINUED</b>	5.4m 4.6m	M/F CL/ANOD	10801 10802 10601 10602
	SW023	Double Glazed Male Stile - Up to 16mm Glass		4.6m 5.4m	M/F CL/ANOD	10601 10602 10801 10802
	SW026	Double Glazed Rail Up to 20mm Glass		6.5m	M/F CL/ANOD	10801 10802
	SW027	Double Glazed Interlock Stile Up to 20mm Glass Fits with SW014/015/016  1721		5.4m	M/F CL/ANOD	10801 10802
	SW028	Double Glazed Lock Stile - Up to 20mm Glass		5.4m	M/F CL/ANOD	10801 10802
	SW029	Double Glazed Meeting Stile - Up to 20mm Glass		5.4m	M/F CL/ANOD	10801 10802

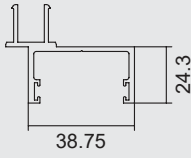
 Key hardware.

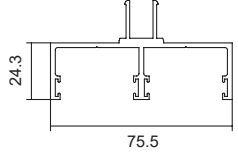
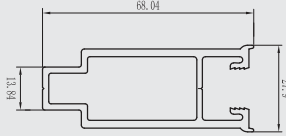
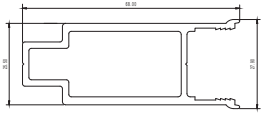

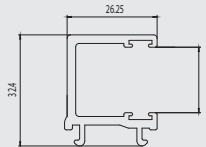



# 101.6MM SLIDING WINDOW SECTIONS

CODE	DESCRIPTION	LGTH.	FINISH	GROUP ID	
SW015	Heavy Interlock  1672, 1832	4.6m	M/F CL/ANOD	10601 10602	
		5.4m	M/F CL/ANOD	10801 10802	
SW014	Medium Interlock  1672, 1831	4.6m	M/F CL/ANOD	10601 10602	
		5.4m	M/F CL/ANOD	10801 10802	
SW016	Standard Interlock  1672, 1830	4.6m	M/F CL/ANOD	10601 10602	
		5.4m	M/F CL/ANOD	10801 10802	
SW025	Interlock To Suit Vent-Lock  1272, 1672	4.6m	M/F CL/ANOD	10601 10602	
SW017	Single Receiver Channel Fits with TJ301  1721	4.6m	M/F CL/ANOD	10601 10602	
SW018	Double Receiver Channel Fits with TJ301  1721	4.6m	M/F CL/ANOD	10601 10602	
SWD044	Patio Corner Stile – Male	5.4m	M/F	10801	
SWD045	Patio Corner D/G Stile – Male - Up to 20mm Glass	4.5m	M/F	10801	
SWD623	Corner Meeting Stile  1842	5.4m	M/F	10801	

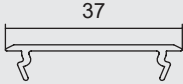
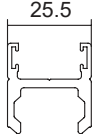
TO BE  
DISCONTINUED

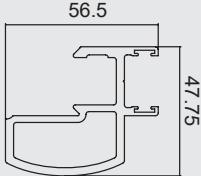
 Key hardware.

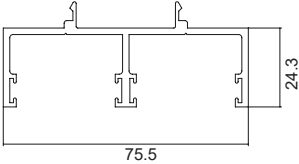









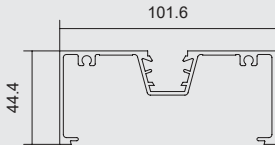
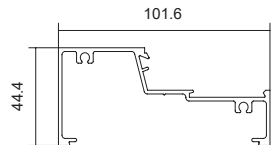
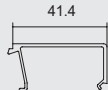
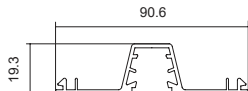

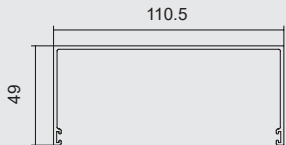
# 101.6MM SLIDING WINDOW SECTIONS

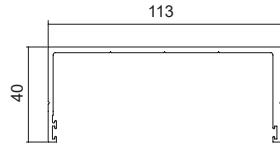
	CODE	DESCRIPTION	LGTH.	FINISH	GROUP ID
	SW019	Threshold	5.3m	M/F CL/ANOD	10601 10602
			6.5m	M/F CL/ANOD	10801 10802
	SW024	Female Adaptor Fits with SW009 / SW010  1721	4.6m	M/F CL/ANOD	10601 10602
			5.4m	M/F CL/ANOD	10801 10802
	SW013	Sliding Window Medium Duty Female Adaptor  1721	4.6m	M/F CL/ANOD	10601 10602
	SW035	Sliding Window Receiver Channel for Centred Double Glazed  1721	4.6m	M/F CL/ANOD	10601 10602

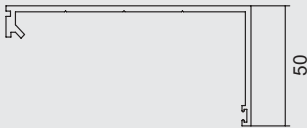

 Key hardware.

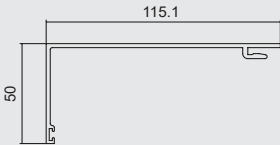
# 101.6MM SLIDING WINDOW SECTIONS

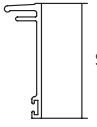
CODE	DESCRIPTION	LGTH.	FINISH	GROUP ID	
TJ301	Standard Main Frame Fits with TJ304/305/306/342/307/ SW017/SW018	6.5m	M/F CL/ANOD BZ/ANOD	8301 8302 8301	
TJ302	Sill Transom Fits with TJ303/304/305	6.5m	M/F CL/ANOD BZ/ANOD	8301 8302 8301	
TJ303	Sill Bead Fits with TJ302	6.5m	M/F CL/ANOD BZ/ANOD	8301 8302 8301	
TJ304	Glazing Adaptor Fits with TJ301/302/306/307/308/335/ TJ6151/6152	6.5m	M/F CL/ANOD BZ/ANOD	8301 8302 8301	
TJ309	49mm Sub Head  1601,1710	6.5m	M/F CL/ANOD BZ/ANOD	10001 10002 10001	
TJ399	Heavy Duty Sub Head  1601,1710	6.5m	M/F CL/ANOD	10001 10002	
TJ430	Two Part Sub Head Fits with TJ429  1601	6.5m	M/F CL/ANOD	10001 10002	
TJ429	Sub Head Cover Fits with TJ430  1601	6.5m	M/F CL/ANOD	10001 10002	
TJ431	Sub Head / Jamb Fits with TJ6159  1601	6.5m	M/F CL/ANOD	10001 10002	
TJ6159	Sub Head / Jamb Cover Fits with TJ431  1601	6.5m	M/F CL/ANOD	10001 10002	

 Key hardware.











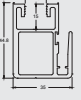



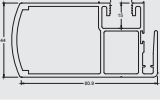

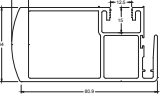

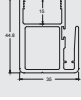

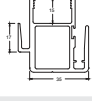

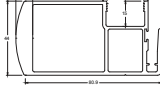

# 101.6MM SLIDING WINDOW SECTIONS

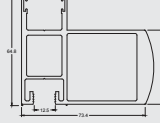
	CODE	DESCRIPTION	LGTH.	FINISH	GROUP ID
	TJ359	Light Duty Sub Sill 12mm Set Back Slotted 1601,1930	6.5m	M/F CL/ANOD BZ/ANOD	10001 10002 10001
	TJ368	STD Sub Sill 6mm Set Back Slotted 1601,1930	6.5m	M/F CL/ANOD	10001 10002
	TJ379	Heavy Duty Sub Sill 12mm Set Back Slotted 1601,1930	6.5m	M/F CL/ANOD	10001 10002
	TJ259	Sub Sill 25mm Set Back Slotted 1601,1930	6.5m	M/F CL/ANOD BZ/ANOD	10001 10002 10001
	TJ432	Sub Sill 35mm Set Back Slotted 1601,1930	6.5m	M/F CL/ANOD	10001 10002
	TJ479	High Performance Sub Sill 22mm Set Back Slotted 1601	6.5m	M/F CL/ANOD	10001 10002
	TJ305	Flush Adaptor Fits with TJ301/302	6.5m	M/F CL/ANOD BZ/ANOD	8301 8302 8301
	TJ342	Reveal Clip-In Fits with TJ301/302	6.5m	M/F CL/ANOD	8301 8302
	TJ345	Fixing Adaptor Fits with TJ301	5.4m	M/F	8301
	TJ370	Sub Sill with Reveal	6.5m	M/F	8301
	TJ385	Back To Back Adaptor	6.5m	M/F	8301

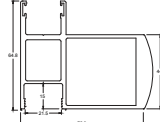

Key hardware.

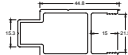
# 101.6MM SLIDING WINDOW SECTIONS

CODE	DESCRIPTION	LGTH.	FINISH	GROUP ID	
SWD050	Single Interlock Stile  1672, 1847, 1848	5.4m	M/F CL/ANOD	10802	
SWD051	Single Interlock with Fly Stiles  1672, 1847, 1848	5.4m	M/F CL/ANOD	10802	
SWD052	Single Interlock Box Stiles  1672, 1847, 1848, 1849	5.4m	M/F CL/ANOD	10802	
SWD053	Single Interlock Heavy Duty Box Stiles  1672, 1847, 1848, 1849	5.4m	M/F CL/ANOD	10802	
SWD060	Double Glazed Single Interlock Stiles  1672, 1847, 1848	5.4m	M/F CL/ANOD	10802	
SWD061	Double Glazed Single Interlock with Fly Stiles  1672, 1847, 1848	5.4m	M/F CL/ANOD	10802	
SWD062	Double Glazed Single Interlock Box Stiles  1672, 1847, 1848, 1849	5.4m	M/F CL/ANOD	10802	
SWD063	Double Glazed Single Interlock Heavy Duty Box Stiles  1672, 1847, 1848, 1849	5.4m	M/F CL/ANOD	10802	
SWD055	Single Glazed H/D Female Adapter  1672, 1849	5.4m	M/F CL/ANOD	10802	
SWD065	Double Glazed H/D Female Adapter  1672, 1849	5.4m	M/F CL/ANOD	10802	
SWD056	Stile Single Glazed	5.4m	M/F CL/ANOD	10802	
SWD066	Stile Double Glazed	5.4m	M/F CL/ANOD	10802	
SWD057	Male Stile Single Glazed	5.4m	M/F CL/ANOD	10802	
SWD067	Male Stile Double Glazed	5.4m	M/F CL/ANOD	10802	

 Key hardware.

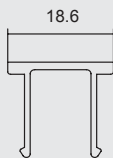
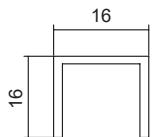
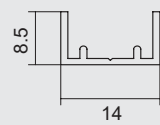
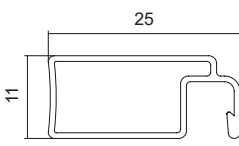
# 101.6MM SLIDING WINDOW SECTIONS

	CODE	DESCRIPTION	LGTH.	FINISH	GROUP ID
	TJ307	Flush Pocket Filler Fits with TJ301/304	6.5m	M/F CL/ANOD BZ/ANOD	8301 8302 8301
	DT3355	Jamb Flyscreen Channel	6.5m	M/F CL/ANOD	2210 2210
	DT3553	Interlock Flyscreen Channel	6.5m	M/F CL/ANOD	2210 2210
	HFF180	Extruded Fly Frame 25 x 11mm  2680, 1850	5.0m	M/F CL/ANOD	2210 2210



 Key hardware.

# SLIDING WINDOW HARDWARE

CODE	DESCRIPTION	U.O.M.	BOX QTY.	GROUP ID	
1600	Bulb Seal PVC - 250m Roll	Roll	1	16169	
1601	Bulb Seal Co-Extruded	Roll	N/A	16169	
1670	Glazing Channel To Suit 6.38mm Glass - 100m Roll	Roll	N/A	16169	
1671	Glazing Channel To Suit 10.38mm Glass - 100m Roll	Roll	N/A	16169	
1676	Glazing Channel To Suit 16mm Glass - 100m Roll	Roll	N/A	16169	
1666	Glazing Channel To Suit 12.38mm Glass - 40m Roll	Roll	N/A	16109	
1667	Glazing Channel To Suit 18mm Glass - 80m Roll	Roll	N/A	16109	
1677	Glazing Channel To Suit 20mm Glass - 80m Roll	Roll	N/A	16169	
1661	Glazing Channel To Suit 20.4mm Glass - 80m Roll	Roll	N/A	16169	
1689	Glazing Channel To Suit 16mm Glass - 60m Roll	Roll	N/A	16169	
1672	Interlock Cushion - 100m Roll	Roll	N/A	16173	
1685	Sill Flap / Insert - 300m Roll	Roll	N/A	16169	
1685-COEX	Sill Flap / Insert Co-Extruded - 200m Roll	Roll	1	16169	
1721	Weatherstrip 67-525 Black with Fin - 400m Roll	Roll	5	16173	
2642	Foam Seal - Slide in - 500m Roll (Everton)	Roll	N/A	16177	
1850	Fly Screen Springs	Each	100	6155	

# SLIDING WINDOW HARDWARE

	CODE	DESCRIPTION	U.O.M.	BOX QTY.	GROUP ID
	1804	Window Wheel - 40kg	Each	100	16109
	1800	Anthony Innovations 9017NA Roller for Single Wheel Patio Door - 40kg	Each	100	16149
	1801	Anthony Innovations 9017DNA Roller for Dual Wheel Patio Door - 80kg	Each	100	16149
	1833	Fixing Clip to Suit Sliding Window Interlock - Bag of 500	Bag	5000	16109
	1836	Fixing Clip to Suit Patio Interlock - Bag of 500	Bag	N/A	16109
	1834	Hole Plug 10mm - Bag of 200	Bag	N/A	16109
	1912	Setting Block / Fixed Panel Spacing Block 10mm - Bag of 500	Bag	N/A	16157
	1963	Universal Stop Suits Sliding Window & Double Hung Window	Bag	N/A	17320
	1964	Universal Sliding Window Stop Packer	Bag	N/A	17320
	1965	Adjustable Anti-lift Block	Bag	N/A	17320
	1830	Filler Block for SW016 - Bag of 20	Bag	N/A	16109
	1831	Filler Block for SW014 Bag of 10 Pairs	Bag	N/A	16109
	1832	Filler Block for SW015 Bag of 10 Pairs	Bag	N/A	16109

# SLIDING WINDOW HARDWARE

CODE	DESCRIPTION	U.O.M.	BOX QTY.	GROUP ID	
1842	Patio Corner Door Block (L & R)	10 pairs p/bag	N/A	16109	
1485	Foam Seal - 695 Pieces Roll Fits with SW001/002/003	Roll	N/A	16177	
1847	Single Interlock Fixed Panel Block SWD050/51/52/53/60/61/62/63	10 pairs p/bag	N/A	16109	
1848	Single Interlock Filler Block SWD050/51/52/53/60/61/62/63	10 pairs p/bag	N/A	16109	
1849	Single Interlock End Cap SWD052/53/55/62/63/65	10 pairs p/bag	N/A	16109	
1270	Doric Keyed Lock - Black	Each	100	16109	
1271	Barron Keyed Sliding Window Lock - Black Key 92608 1273,1276	Each	100	16109	
1274	Slimline Barron Sliding Window Lock - Black Key 92608	Each	N/A	16109	
1273	Sliding Window Barron Lock - 2mm Packer 1271	Each	100	16109	
1276	3mm Packer for Strike on the Cityview Barron Locks Suits 1271/1274	Each	N/A	16109	
1267-**	Pearl Sliding Window Lock, Keyed Alike Key #7010  **Specify finish: Black-BL, Silver-SCA	Each	10	16109	
1272	Sliding Window Vent Lock Keyed	Each	N/A	16109	
2680	Corner Stake to Suit HFF180 (Plastic)	Each	500	6152	

Key hardware.

# SLIDING WINDOW HARDWARE

	CODE	DESCRIPTION	U.O.M.	BOX QTY.	GROUP ID
	1370**	Dow Corning 688 Silicone Glazing & Cladding Sealant <i>688**Specify finish: Black-BL, Translucent-Trans, White-WH.</i> 	Tube	24	16161
	1371**	Dow Corning 795 Structural Glazing Silicone <i>795**Specify finish: Black-BL.</i> 	Sausage	20	16161
	1311**	Dow Corning 680 Sanitary Silicone - Tube (Neutral Cure) <i>680**Specify finish: Transparent-TR White-WH.</i> 	Tube	20	16161
	1900-M	Frame Packers - 1.5mm X 90mm Blue 100/Bag	Bag	N/A	16157
	1901-M	Frame Packers - 3mm X 90mm Green 100/Bag	Bag	N/A	16157
	1902-M	Frame Packers - 5mm X 90mm Orchre 100/Bag	Bag	N/A	16157
	1903-M	Frame Packers - 10mm X 90mm Black 100/Bag	Bag	N/A	16157
	1910	Setting Blocks 3mm Thick	Bag	N/A	16157
	1911	Setting Blocks 5mm Thick	Bag	N/A	16157
	1912	Setting Blocks 10mm Thick	Bag	N/A	16157
	1977	Setting Blocks 5mm X 25mm - 3m Self Adhesive	Bag	N/A	17320
	1978	Setting Blocks 10mm X 25mm - 3m Self Adhesive	Bag	N/A	17320
	1979	Setting Blocks 3mm X 10mm X 25mm - 3m Double Sided Tape	Bag	N/A	17320
	1930	End Cap To Suit Subsills Bag of 50 Pairs ( <i>Left &amp; Right</i> )	Bag	N/A	16157
	1960	Lanotec General Purpose Liquid Lanolin 400g	Tube	12	16181
	1961	Lanotec "Citra Force" Cleaner Degreaser 400g	Tube	12	16181



Please check with your local branch for stock availability.

# SYSTEM TOOLING

**CODE**      **DESCRIPTION**

DTL3106      101.6mm Sliding Window / Patio Door Drilling Jig  
Suits SW009/010/011/012/022/023



DTL3107      Stepped Drill Bit  
To Suit DT3106 Jig

DTL3110-  
AIR      Sliding Window / Patio Door Air Operated Tool



DTL3112      101.6m    Patio Door & Sliding Window Jamb Tool



DTL3116      101.6m    Sliding Window Jamb Drill Jig







**101.6mm DOUBLE HUNG WINDOW**









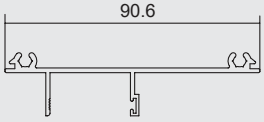

**DOUBLE HUNG WINDOW**

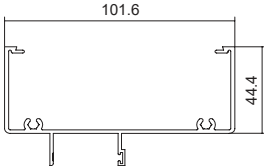
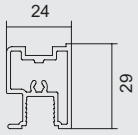
GLASS THICKNESS	CHANNEL RUBBER REQUIRED	POCKET SIZE
4mm	1690	10mm
5mm	1691	
6mm	1692	
12mm	1666	22mm
16mm	1689	
18mm	1667	
20mm	1677	

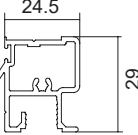

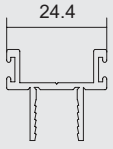
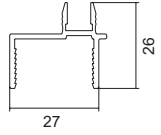
# 101.6MM DOUBLE HUNG WINDOW SECTIONS

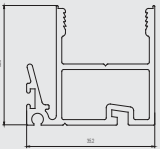
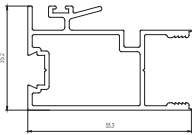
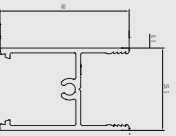
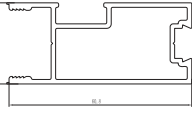
CODE	DESCRIPTION	LGTH.	FINISH	GROUP ID	
DH107	Snap In Head Fits with TJ302  1714	6.5m	M/F CL/ANOD	10701 10702	
DH109	Head  1714	6.5m	M/F CL/ANOD	10701 10702	
DH110	Rail	6.5m	M/F CL/ANOD	10701 10702	
DH111	Interlock  1715	6.5m	M/F CL/ANOD	10701 10702	
DH114	Sash  1705	6.5m	M/F CL/ANOD	10701 10702	
DH116	Double Hung Double Glazed Adaptor	6.5m	M/F CL/ANOD	10701 10702	
DH252	Double Hung Interlock Rail 20mm Pocket  1928	6.5m	M/F	10701	
DH253	Double Hung Interlock Rail 20mm Pocket	6.5m	M/F	10701	
DH255	Double Hung Stile 20mm Pocket	6.5m	M/F	10701	
DH258	Double Hung Sash Stile 20mm Pocket	6.5m	M/F	10701	

**TO BE  
DISCONTINUED**

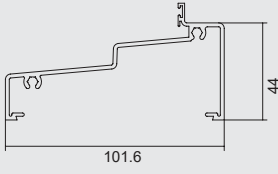
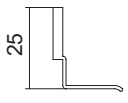
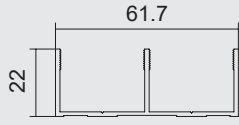
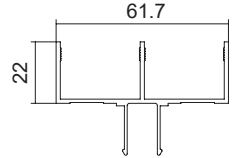
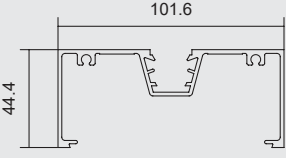
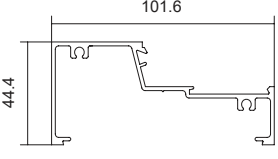
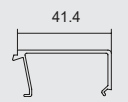
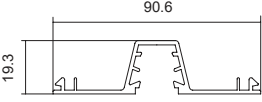
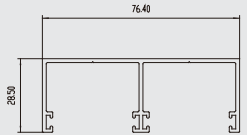

 Key hardware.

# 101.6MM DOUBLE HUNG WINDOW SECTIONS

	CODE	DESCRIPTION	LGTH.	FINISH	GROUP ID
	DH112	Sill Key 1714	6.5m	M/F CL/ANOD	10701 10702
	DH115	High Performance Sill Adaptor Fits with DH112	6.5m	M/F CL/ANOD	10701 10702
	DH113	Jamb Screw Fix	6.5m	M/F CL/ANOD	10701 10702
	DH108	Snap In Jamb Fits with TJ301	6.5m	M/F CL/ANOD	10701 10702
	TJ301	Standard Main Frame Fits with TJ304/305/306 TJ307/335	6.5m	M/F CL/ANOD BZ/ANOD	8301 8302 8301
	TJ302	Sill Transom Fits with DH107	6.5m	M/F CL/ANOD BZ/ANOD	8301 8302 8301
	TJ303	Sill Bead Fits with TJ302	6.5m	M/F CL/ANOD BZ/ANOD	8301 8302 8301
	TJ304	Glazing Adaptor Fits with TJ301/302/DH112	6.5m	M/F CL/ANOD BZ/ANOD	8301 8302 8301
	DH117	Double Glazed Jamb Adaptor	6.5m	M/F CL/ANOD	8301 8302 8301



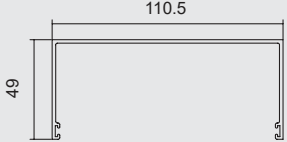
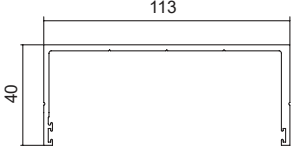
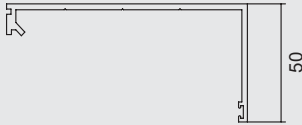

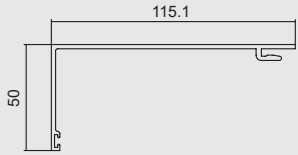
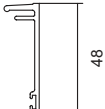





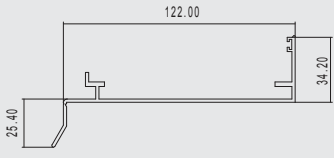

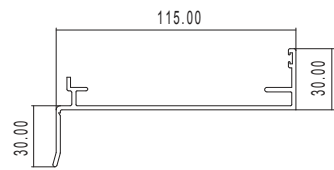
 Key hardware.

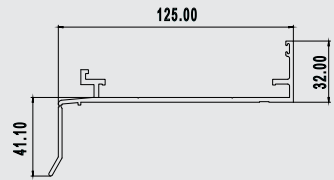
# 101.6MM DOUBLE HUNG WINDOW SECTIONS

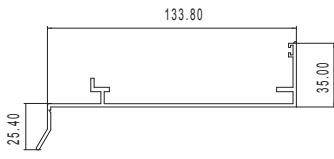
CODE	DESCRIPTION	LGTH.	FINISH	GROUP ID	
TJ309	49mm Sub Head <span>🔑</span> 1601, 1710	6.5m	M/F CL/ANOD BZ/ANOD	10001 10002 10001	
TJ399	Heavy Duty Sub Head <span>🔑</span> 1601, 1710	6.5m	M/F CL/ANOD	10001 10002	
TJ430	Two Part Sub Head Fits with TJ429 <span>🔑</span> 1601	6.5m	M/F CL/ANOD	10001 10002	
TJ429	Sub Head Cover Fits with TJ430 <span>🔑</span> 1601	6.5m	M/F CL/ANOD	10001 10002	
TJ431	Sub Head Fits with TJ6159 <span>🔑</span> 1601	6.5m	M/F CL/ANOD	10001 10002	
TJ6159	Cover Fits with TJ431 <span>🔑</span> 1601	6.5m	M/F CL/ANOD	10001 10002	

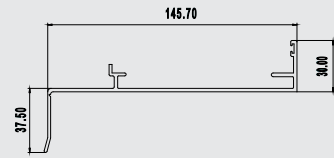
🔑 Key hardware.

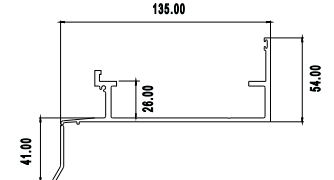
# 101.6MM DOUBLE HUNG WINDOW SECTIONS

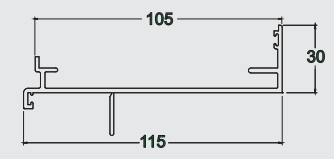
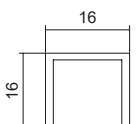
	CODE	DESCRIPTION	LGTH.	FINISH	GROUP ID
	TJ359	Light Duty Sub Sill 12mm Set Back Slotted  1601, 1930	6.5m	M/F CL/ANOD BZ/ANOD	10001 10002 10001
	TJ368	STD Sub Sill 6mm Set Back Slotted  1601, 1930	6.5m	M/F CL/ANOD	10001 10002
	TJ379	Heavy Duty Sub Sill 12mm Set Back Slotted  1601, 1930	6.5m	M/F CL/ANOD	10001 10002
	TJ259	Sub Sill 25mm Set Back Slotted  1601, 1930	6.5m	M/F CL/ANOD BZ/ANOD	10001 10002 10001
	TJ432	Sub Sill 35mm Set Back Slotted  1601, 1930	6.5m	M/F CL/ANOD	10001 10002
	TJ479	High Performance Sub Sill 22mm Set Back Slotted  1601	6.5m	M/F CL/ANOD	10001 10002
	TJ370	Sub Sill with Reveal	6.5m	M/F	8301
	DT3355	Jamb Flyscreen Channel	6.5m	M/F CL/ANOD	2211 2212

 Key hardware.

# 101.6MM DOUBLE HUNG WINDOW SECTIONS

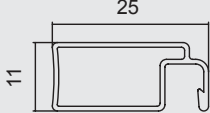
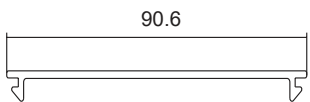
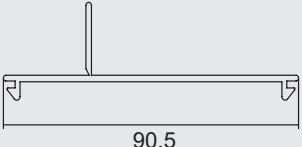
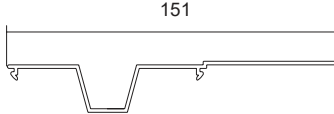
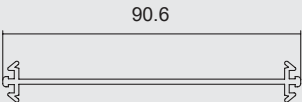
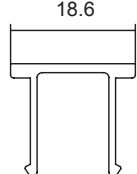
CODE	DESCRIPTION	LGTH.	FINISH	GROUP ID	
HFF180	Extruded Fly Frame 25 x 11mm  2680, 1850	5.0m	M/F CL/ANOD	8301 8302	
TJ305	Flush Adaptor Fits with TJ301/302	6.5m	M/F CL/ANOD BZ/ANOD	8301 8302 8301	
TJ342	Reveal Clip-In Fits with TJ301/302	6.5m	M/F CL/ANOD	8301 8302	
TJ345	Fixing Adaptor Fits with TJ301	5.4m	M/F CL/ANOD	8301 8302	
TJ385	Back to Back Adaptor	6.5m	M/F CL/ANOD	8301 8302	
TJ307	Flush Pocket Filler Fits with TJ301/304	6.5m	M/F CL/ANOD BZ/ANOD	8301 8302 8301	









 Key hardware.

# DOUBLE HUNG WINDOW HARDWARE

	CODE	DESCRIPTION	U.O.M.	BOX QTY.	GROUP ID
	1275	Double Hung Accessory Package <i>Note: Springs Are "Non Stocked" Request Order Sheet from Customer Service.</i>	Set 	N/A	16105
	1470	Foam Seal - Suits 101.6mm Double Hung Head (Set: L&R), 455 Sets on a Roll	Roll	N/A	16177
	1471	Foam Seal - Suits 101.6mm Double Hung Sill (Set: L&R), 475 Sets on a Roll	Roll	N/A	16177
	2280-**	Whitco Keyed Double Hung Lock Suits DH111 <i>**Specify finish: Black-BL, Satin Chrome-SC.</i>	Each 	10	6131
	1928	Doric Double Hung Cam Sash Suits DH252	Each	Each	17320
	2281	Double Hung Lock Keeper - Suits 2280, S/Steel	Each	50	16105
	1601	Bulb Seal Co-Extruded	Roll	N/A	16169
	1677	Glazing Channel to Suit 20mm Glass - 80m Roll	Roll	N/A	16169
	1690	Glazing Channel To Suit Double Hung 4mm Glass - 80m Roll	Roll	N/A	16169
	1691	Glazing Channel To Suit Double Hung 5mm Glass - 100m Roll	Roll	N/A	16169
	1692	Glazing Channel To Suit Double Hung 6mm Glass - 150m Roll	Roll	N/A	16169
	1693	Glazing Channel To Suit Double Hung 18mm Glass - 60m Roll	Roll	1	16169
	1705	Weatherstrip 48-525 Black - 500m Roll	Roll	5	16173
	1714	Weatherstrip 48-625 Black - 450m Roll	Roll	5	16105
	1715	Weatherstrip 48-850 Black - 350m Roll	Roll	5	16105
	2642	Foam Seal - Slide in - 500m Roll	Roll	N/A	16177

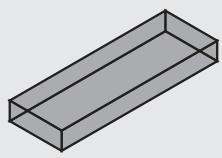
 Please check with your local branch for stock availability.

# DOUBLE HUNG WINDOW HARDWARE

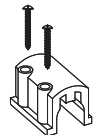
CODE	DESCRIPTION	U.O.M.	BOX QTY.	GROUP ID	
1370**	Dow Corning 688 Silicone Glazing & Cladding Sealant <i>688**Specify finish: Black-BL, Translucent-Trans, White-WH.</i>	Tube	24	16161	
1371**	Dow Corning 795 Structural Glazing Silicone <i>795**Specify finish: Black-BL.</i>	Sausage	20	16161	
1311**	Dow Corning 680 Sanitary Silicone - Tube (Neutral Cure) <i>680**Specify finish: Transparent-TR White-WH.</i>	Tube	20	16161	
1900-M	Frame Packers - 1.5mm X 90mm Blue 100/Bag	Bag	N/A	16157	
1901-M	Frame Packers - 3mm X 90mm Green 100/Bag	Bag	N/A	16157	
1902-M	Frame Packers - 5mm X 90mm Orchre 100/Bag	Bag	N/A	16157	
1903-M	Frame Packers - 10mm X 90mm Black 100/Bag	Bag	N/A	16157	
1910	Setting Blocks 3mm Thick	Bag	N/A	16157	
1911	Setting Blocks 5mm Thick	Bag	N/A	16157	
1912	Setting Blocks 10mm Thick	Bag	N/A	16157	
1977	Setting Blocks 5mm X 25mm - 3m Self Adhesive	Bag	N/A	17320	
1978	Setting Blocks 10mm X 25mm - 3m Self Adhesive	Bag	N/A	17320	
1979	Setting Blocks 3mm X 10mm X 25mm - 3m Double Sided Tape	Bag	N/A	17320	
1930	End Cap To Suit Subsills Bag of 50 Pairs - Left + Right	Bag	N/A	16157	
1943	53mm Double Hung Bottom Stops - Black	Bag	N/A	17320	
1960	Lanotec General Purpose Liquid Lanolin 400g	Tube	12	16181	
1961	Lanotec "Citra Force" Cleaner Degreaser 400g	Tube	12	16181	
1963	Window Spring Cover Stops	Bag	20	17320	

 Please check with your local branch for stock availability.



# SYSTEM TOOLING

	CODE	DESCRIPTION	U.O.M.	BOX QTY	GROUP ID
	DTL3103	101.6mm Double Hung Press Suits DH107/111/114	Each	N/A	N/A
N/A	DTL3104	Double Hung Drilling Jig for Springs Suits DH108/113	Each	N/A	N/A
N/A	DTL3105	Double Hung Drilling Jig Suits DH109/112	Each	N/A	N/A



# SPECIAL FEATURE



## NEW GUILLOTINE & BRAKE PRESS MACHINES

### *Now available in Darley's Victorian Office*

Darley is pleased to announce that the new aluminium guillotine and brake press machines are now in operation in the Darley Victorian office.

The guillotine machine cuts the aluminium sheets to size and the brake press machine folds & bends the sheets. Both machines have the capabilities to handle lengths of up to 3.6m sheets and a sheet thickness of 1.2mm to 4mm. We also offer the option of **In-house Powder Coating** for all aluminium sheets. Contact your Account Manager or local Darley branch to find out more.

Guillotine Machine	
Type of Sheet	Flat aluminium sheets cut to size
Lengths	Up to 3.6m sheets
Sheet Thickness	From 1.2mm to 4mm

Brake Press Machine	
Lengths	Up to 3.6m sheets
Sheet Thickness	From 1.2mm to 4mm
Types of Folds	Made to size: <ul style="list-style-type: none"><li>• Top hat</li><li>• Angles</li><li>• Z shape flashings</li></ul>

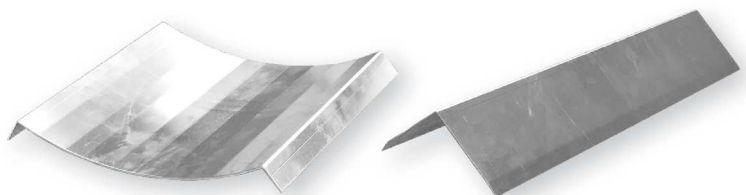



**AWNING & CASEMENT WINDOW**



**35 AWNING SASHES  
FOR TJ722, TJ723, TJ724 & TJ729**

GLASS THICKNESS	BEAD REQUIRED	WEDGE REQUIRED
6mm	TJ709	1620 or 1601
8 mm	TJ709	1630 or 1601
10 mm	TJ709	1630 or 1601
12mm	TJ713	1615
	TJ713	1620
16mm	TJ713	1620
	TJ713	1630
18mm	TJ713	1630
20mm	TJ016	1615
22mm	TJ016	1615
	TJ016	1601
24mm	TJ016	1620 or 1601

**50 AWNING SASH  
FOR TJ741 & TRUTH SASH**

GLASS THICKNESS	BEAD REQUIRED	WEDGE REQUIRED
6mm	TJ714	1931
10 mm	TJ714	1615
12mm	TJ714	1620
16mm	TJ716	1931
18mm	TJ716	1931
20mm	TJ716	1933
22mm	TJ716	1615
24mm	TJ716	1630
28mm	TJ717	1932
30mm	TJ717	1933





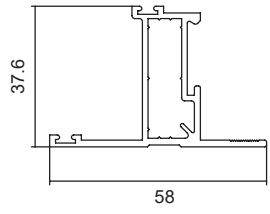
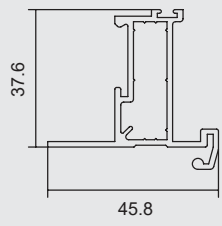
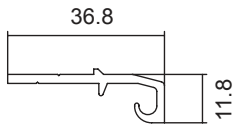



# AWNING & CASEMENT WINDOW SECTIONS

CODE	DESCRIPTION	LGTH.	FINISH	GROUP ID	
TJ723	35 Awning Sash with 58mm Flat Face Fits with TJ300/301/390/709/720/016 <b>Key</b> 1851, 1601, 1854	6.5m	M/F CL/ANOD BZ/ANOD	9901 9902 9901	
TJ722	35 Awning Sash with 58mm Rebate Face Fits with TJ301/300/390/709/720/016 <b>Key</b> 1851, 1601, 1854	6.5m	M/F CL/ANOD BZ/ANOD	9901 9902 9901	
TJ724	35 Hinge Awning Sash Fits with TJ016/709/725 <i>*Use only with TJ722*</i> <b>Key</b> 1851, 1601, 1854	6.5m	M/F CL/ANOD	9901 9902	
TJ725	35 Awning Sash Hinge Suits TJ722/300/301/304/390	6.5m	M/F CL/ANOD BZ/ANOD	9901 9902 9901	

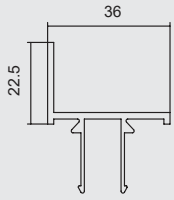
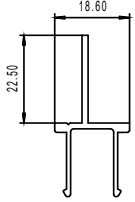
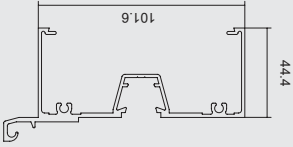
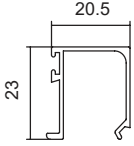

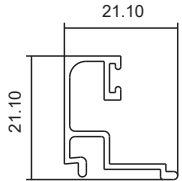
**Key** Key hardware.

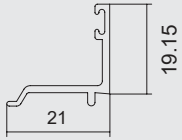











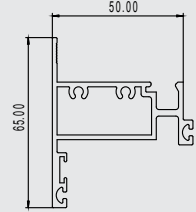

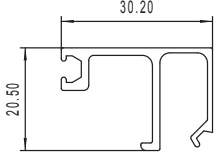
# AWNING & CASEMENT WINDOW SECTIONS

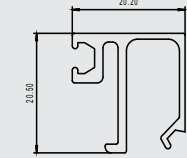
	CODE	DESCRIPTION	LGTH.	FINISH	GROUP ID
	TJ720	35 Awning Stop Fits with TJ301/300/390/304/722/723	6.5m	M/F CL/ANOD BZ/ANOD	9901 9902 9901
	TJ715	50 Awning Sash Stop Fits with TJ301/724 Suits Sash TJ741	6.5m	M/F CL/ANOD	9901 9902
	TJ728	35 Awning Hinge Frame Fits with TJ724	6.5m	M/F CL/ANOD	8301 8302
	TJ709	6-10mm 35 Awning Glazing Bead Fits with TJ722/723/724/729  1620, 1615, 1630	6.5m	M/F CL/ANOD BZ/ANOD	9401 9402 9401
	TJ314	Slope 35 Awning / Door Bead Fits with TJ726/313/315	6.5m	M/F CL/ANOD BZ/ANOD	9401 9402 9401
	TJ713	10-18mm 35 Awning Glazing Bead Fits with TJ722/723/724/729  1615, 1620, 1630	6.5m	M/F CL/ANOD	9901
	TJ016	20-24mm 35 Double Glazing Bead Fits with TJ722/723/724  1615, 1620, 1630	6.5m	M/F CL/ANOD	10301 10302

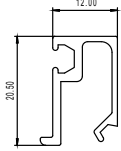
AVAILABLE  
IN NSW ONLY

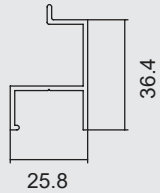
 Key hardware.

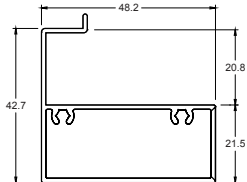

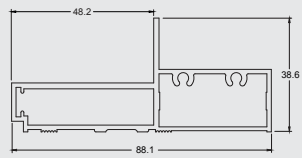

# AWNING & CASEMENT WINDOW SECTIONS

CODE	DESCRIPTION	LGTH.	FINISH	GROUP ID	
TJ741	50 Heavy Duty Awning Sash Fits with TJ714/716/717  1863, 1864, 2641, 1855 	6.5m	M/F CL/ANOD		
TJ714	6-12mm 50 Awning Bead Fits with TJ741  1615, 1620, 1931	6.5m	M/F CL/ANOD	9901 9902	
TJ716	16-24mm 50 Awning Bead Fits with TJ741  1615, 1630, 1931, 1933	6.5m	M/F CL/ANOD	9901 9902	
TJ717	28-30mm 50 Awning Bead Fits with TJ741  1932, 1933	6.5m	M/F CL/ANOD	9901 9902	
TJ737	Flyscreen Adaptor/Winder Support Fits with TJ301/720/736  1080, 1090	6.5m	M/F CL/ANOD	9901 9902	
TJ734	Chain Winder Support  1080, 1090	6.5m	M/F CL/ANOD	TBA	
TJ745	HD Awning Flush Recess Stop  1863, 1864, 1855	6.5m	M/F	9901	

 Key hardware.

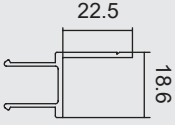
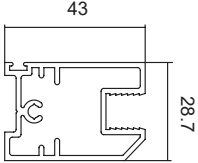
 Technical guidance recommended.

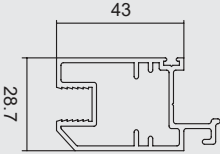
# AWNING & CASEMENT WINDOW SECTIONS

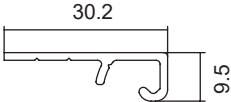
	CODE	DESCRIPTION	LGTH.	FINISH	GROUP ID
	TJ736	Sash Stop Fits with TJ301/738/739	6.5m	M/F CL/ANOD	9901 9902
	TJ738	Awning Sash Fits with TJ739  1605	6.5m	M/F CL/ANOD	9901 9902
	TJ739	Hinge Sash  1605	6.5m	M/F CL/ANOD	9901 9902
	TJ740	Window Hinge Fits with TJ739/TJ301	6.5m	M/F CL/ANOD	9901 9902

# TRUTH / AWNING WINDOW SECTIONS

	CODE	DESCRIPTION	LGTH.	FINISH	GROUP ID
	TJ770	Awning/Casement Sash Fits with 1855  1863, 1864, 2641, 1855	6.5m	M/F	9901
	TJ771	Awning/Casement Head and Sill Adapter	6.5m	M/F	9901
	TJ772	Awning/Casement Jamb Adapter	6.5m	M/F	9901

 Key hardware.

# AWNING & CASEMENT WINDOW HARDWARE

CODE	DESCRIPTION	U.O.M.	BOX QTY.	GROUP ID	
1080**	Whitco Mk8 Non-Locking Chainwinder - Standard <i>**Specify finish: Black - BL, White - WH, Primose - PR.</i>	Each	10	16137	
1082	Whitco Mk8 Non-Locking Chainwinder - Black Non Corrosive	Each	10	16137	
1090	Whitco Mk8 Locking Chainwinder - K/N 32381 - Standard <i>**Specify finish: Black-BL, White Birch - WB, White - WH, Primose - PR, Silver - SCA.</i>	Each	10	16137	
1092	Locking Chainwinder - Black K/N 32381 - Non-corrosive	Each	NA	16137	
1098-SQ	Chain Length Restriction Plug - Works with 1080, 1082, 1090, 1092	Each	10	16137	
1227	DS1 Doric Locking Stainless Steel Chainwinder - Black	Each	NA	16137	
1099	Chainwinder Bracket - Black Height = 20mm	Each	20	16137	
1240	Awning Handle - Wedgeless Right Hand - Black Non-Locking	Each	10	16149	 <i>Right Hand Non-Locking Shown</i>
1241	Awning Handle - Wedgeless Left Hand - Black Non-Locking	Each	10	16149	
1242	Awning Handle - Wedgeless Right Hand - Black Locking	Each	10	16149	
1243	Awning Handle - Wedgeless Left Hand - Black Locking	Each	10	16149	
1244	High Performance Cam Handle Lock - To Suit TJ741 - Right Hand - Black Non-Locking	Each	10	16145	
1245	High Performance Cam Handle Lock - To Suit TJ741 - Left Hand - Black Non-Locking	Each	10	16145	
1246	High Performance Cam Handle Lock - To Suit TJ741 - Right Hand - Black Locking	Each	10	16145	
1247	High Performance Cam Handle Lock - To Suit TJ741 - Left Hand - Black Locking	Each	10	16145	



Please check with your local branch for stock availability.



# AWNING & CASEMENT WINDOW HARDWARE

	CODE	DESCRIPTION	U.O.M.	BOX QTY.	GROUP ID
	1200	Aluminium A Stay Awning 235mm - Friction - Black - 6kg Max Height = 750mm Stack Height = 13mm	Pair	30pr	16141
	1201	Aluminium A Stay Awning 235mm - Non Friction - Black - 10kg Stack Height = 13mm	Pair	30pr	16141
	1210	Stainless Steel 254mm Awning Stay Max = 450mm/14kg/84° Stack Height = 13mm	Pair	25pr	16141
	1211	Stainless Steel 402.5mm Awning Stay Max = 550mm/20kg/60° Stack Height = 13mm	Pair	25pr	16141
	1212	Stainless Steel 502.5mm Awning Stay Max = 1200mm/24kg/45° Stack Height = 13mm	Pair	25pr	16141
	1237	Stainless Steel 602mm Awning Stay Max = 1800mm/35kg Stack Height = 13mm	Pair	25pr	16141
	1220	Stainless Steel Restrictor Stay - Light Duty	Pair	25pr	16141
	1281	263mm Heavy Duty Stainless Steel Stay Max Height = 762mm/ Max Width = 1200mm/Max Weight = 35kg Stack Height = 16mm <i>*Awning Only*</i>	Pair	25pr	16141
	1282	414mm Heavy Duty Stainless Steel Stay Max Height = 1120mm/ Max Width = 1200mm/Max Weight = 37kg Stack Height = 16mm	Pair	25pr	16141
	1283	567mm Heavy Duty Stainless Steel Stay Max Height = 1321mm/ Max Width = 1600mm/Max Weight = 42kg Stack Height = 16mm	Pair	25pr	16141
	1213	683mm Heavy Duty Stainless Steel Stay Max Height = 1800mm/ Max Width = 1800mm/Max Weight = 90kg Stack Height = 16mm <i>*Awning Only*</i>	Pair	25pr	16141
	1284	724mm Heavy Duty Stainless Steel Stay Max Height = 2000mm/ Max Width = 2000mm/Max Weight = 130kg Stack Height = 16mm <i>*Awning Only*</i>	Pair	25pr	16141
	1285	Stainless Steel Restrictor Stay - Heavy Duty	Pair	25pr	16141

# AWNING & CASEMENT WINDOW HARDWARE







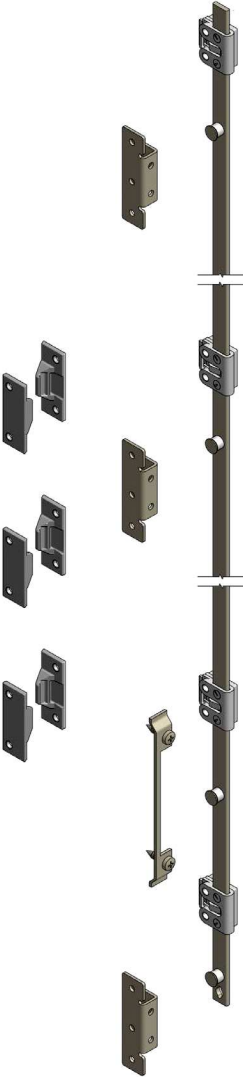



CODE	DESCRIPTION	U.O.M.	BOX QTY.	GROUP ID	
21001/ AWNKIT1SS	Awning Operator Kit #1 - Stainless Steel For Sashes 500-700mm High - 26kg MAX	Set	N/A	16137	
21001/ AWNKIT2SS	Awning Operator Kit #2 - Stainless Steel For Sashes 701-900mm High - 45kg MAX	Set	N/A	16137	
21001/ AWNKIT3SS	Awning Operator Kit #3 - Stainless Steel For Sashes 901-1050m High - 53kg MAX	Set	N/A	16137	
21001/ AWNKIT4SS	Awning Operator Kit #4 - Stainless Steel For Sashes 1051-1200mm High - 58kg MAX	Set	N/A	16137	
21001/ AWNKIT5SS	Awning Operator Kit #5 - Stainless Steel For Sashes 1201-1600mm High - 80kg	Set	N/A	16137	
21001/ AWNKIT6SS	Awning Operator Kit #6 - Stainless Steel For Sashes 1601-2100mm High - 136kg MAX	Set	N/A	16137	
21002/ CASKT1LSS	Casement Operator Kit #1 - LH SS For Sashes 450-600mm Wide L/H Open	Set	N/A	16137	
21002/ CASKT1RSS	Casement Operator Kit #1 - RH SS For Sashes 651-1000mm Wide L/H Open	Set	N/A	16137	
21002/ CASKT2LSS	Casement Operator Kit #1 - RH SS For Sashes 450-600mm Wide L/H Open	Set	N/A	16137	
21002/ CASKT2RSS	Casement Operator Kit #2 - RH SS For Sashes 651-1000mm Wide L/H Open	Set	N/A	16137	
21003/ CVHANLSIL	Tango Cover & Handle LH - Alum Encore	Set	N/A	16137	
21003/ CVHANLCLK	Tango Cover & Handle LH - Black Encore	Set	N/A	16137	
21003/ CVHANLWH	Tango Cover & Handle LH - White Encore	Set	N/A	16137	
21004/ CVHANRSIL	Tango Cover & Handle RH - Alum Encore	Set	N/A	16137	
21004/ CVHANRCLK	Tango Cover & Handle RH - Black Encore	Set	N/A	16137	
21004/ CVHANRWH	Tango Cover & Handle RH - White Encore	Set	N/A	16137	
21005/ KEYCVLSIL	Key Lock Cover & Handle LH - Alum NO Cylinder	Set	N/A	16137	
21005/ KEYCVLCLK	Key Lock Cover & Handle LH - Black NO Cylinder	Set	N/A	16137	
21005/ KEYCVLWH	Key Lock Cover & Handle LH - White NO Cylinder	Set	N/A	16137	
21006/ KEYCVRSIL	Key Lock Cover & Handle RH - Alum NO Cylinder	Set	N/A	16137	
21006/ KEYCVRCLK	Key Lock Cover & Handle RH - Black NO Cylinder	Set	N/A	16137	
21006/ KEYCVRWH	Key Lock Cover & Handle RH - White NO Cylinder	Set	N/A	16137	
21007/ WFCYL	FSA Wafer Cyl K/N:32304 wth Exchange Barrel for Encore Locking (1 per Cover)	Each	N/A	16137	

 Key hardware.

# AWNING & CASEMENT WINDOW HARDWARE



	CODE	DESCRIPTION	U.O.M.	BOX QTY.	GROUP ID
	21011/ SPLHNSIL	Singlepoint Lock and Handle Kit Stainless Steel. For Awning Sashes up to 700mm High (Silver)	Set	N/A	16137
	21011/ SPLHNBLK	Singlepoint Lock and Handle Kit Stainless Steel. For Awning Sashes up to 700mm High (Black)	Set	N/A	16137
	21011/ SPLHNWH	Singlepoint Lock and Handle Kit Stainless Steel. For Awning Sashes up to 700mm High (White)	Set	N/A	16137
	21008/ MPTKT1LSS	Multipoint Lock Kit #1 LH Stainless Steel For Awning Sashes 1201-2100mm High	Set	N/A	16137
	21008/ MPTKT2LSS	Multipoint Lock Kit #2 LH Stainless Steel For Casement Sashes 1201-1500mm High	Set	N/A	16137
	21008/ MPTKT2RSS	Multipoint Lock Kit #2 RH Stainless Steel For Casement Sashes 1201-1500mm High	Set	N/A	16137
	21008/ MPTKT3LSS	Multipoint Lock Kit #3 LH Stainless Steel For Casement Sashes 1501-1600mm High	Set	N/A	16137
	21008/ MPTKT3RSS	Multipoint Lock Kit #3 LH Stainless Steel For Casement Sashes 1501-1600mm High	Set	N/A	16137
	21008/ MPTKT4LSS	Multipoint Lock Kit #4LH Stainless Steel For Casement Sashes 1601-1700mm High	Set	N/A	16137
	21008/ MPTKT4RSS	Multipoint Lock Kit #4 LH Stainless Steel For Casement Sashes 1601-1700mm High	Set	N/A	16137
	21008/ MPTKT5LSS	Multipoint Lock Kit #5 LH Stainless Steel For Casement Sashes 1701-1800mm High	Set	N/A	16137
	21008/ MPTKT5RSS	Multipoint Lock Kit #5 LH Stainless Steel For Casement Sashes 1701-1800mm High	Set	N/A	16137
	21008/ MPTKT6LSS	Multipoint Lock Kit #6 LH Stainless Steel For Casement Sashes 1801-1900mm High	Set	N/A	16137
	21008/ MPTKT6RSS	Multipoint Lock Kit #6 LH Stainless Steel For Casement Sashes 1801-1900mm High	Set	N/A	16137
	21008/ MPTKT7LSS	Multipoint Lock Kit #7 LH Stainless Steel For Casement Sashes 1901-2350mm High	Set	N/A	16137
	21008/ MPTKT7RSS	Multipoint Lock Kit #7 LH Stainless Steel For Casement Sashes 1901-2350mm High	Set	N/A	16137
		21010/ MPTLHNSIL	Multi Point Locking Handle - Alum Maxim (with Gasket)	Set	N/A
21010/ MPTLHNBLK		Multi Point Locking Handle - Black Maxim (with Gasket)	Set	N/A	16137
21010/ MPTLHNWH		Multi Point Locking Handle - White Maxim (with Gasket)	Set	N/A	16137

# AWNING & CASEMENT WINDOW HARDWARE

CODE	DESCRIPTION	U.O.M.	BOX QTY.	GROUP ID	
1450	Glazing Tape - D/Sided Black PVC 1.6mm x 12mm - 45.7m Roll	Roll	20	16165	
1451	Glazing Tape - D/Sided Black PVC 3.2mm x 12mm - 25m Roll	Roll	20	16165	
1452	Glazing Tape - D/Sided Black PVC 4.8mm x 12mm - 15.2m Roll	Roll	20	16165	
1453	Glazing Tape - D/Sided Black PVC 6.4mm x 12mm - 15.2m Roll	Roll	20	16165	
1600	Bulb Seal PVC - 250m Roll	Roll	1	16169	
1601	Bulb Seal Co-Extruded - 100m Roll	Roll	N/A	16169	
2641	Qlon - Push in - 500m Roll Suits TJ741	Roll	N/A	16169	
1615	Glazing Wedge PVC - 200m Roll Suits TJ202	Roll	1	16169	
1620	Glazing Wedge PVC - 200m Roll	Roll	1	16169	
1630	Glazing Wedge PVC - 200m Roll	Roll	1	16169	
1605	Glazing Channel to Suit 6mm Awning Window - 200m Roll Suits TJ738/739	Roll	N/A	16169	
1931	Glazing Wedge 100m Roll	Roll	1	17320	
1932	Glazing Wedge 125m Roll	Roll	1	17320	
1933	Glazing Wedge 150m Roll	Roll	1	17320	

WA SASH ONLY

# AWNING & CASEMENT WINDOW HARDWARE

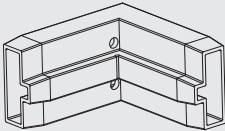
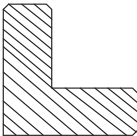
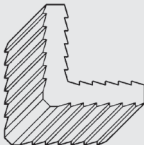
	CODE	DESCRIPTION	U.O.M.	BOX QTY.	GROUP ID
	1851	35 Corner Stake for Awning Sash Suits TJ722/723/724/725/726/729	Each	100	16153
	1854	35 Corner Stake for Sash Suitable for Crimping Suits TJ722/723	Each	100	16153
	1863	50 Plastic Corner Stake for TJ741/770 (left & right handed)	Bag	20	16153
	1864	50 Sash Corner Stake for TJ741/770	Bag	100	16153
	1855	50 Metal Corner Stake for TJ741/770	Bag	20	16153







## MULTIFOLD DOOR SYSTEM



STANDARD MULTIFOLD DOOR SYSTEM 45MM FLUSH FACE DOOR (WATER RATED)		
GLASS THICKNESS	WEDGE REQUIRED	POCKET SIZE
6mm	1620 - 1620 OR 1620 - 1651 OR 1620 - 1684	14.5mm
8mm	1630 - 1651 OR 1630 - 1684	
10mm	1630 - 1630	
20mm	1933 - 1933	35.1mm
22mm	1615 - 1933	
24mm	1615 - 1615 OR 1933 - 1684	
26mm	1615 - 1620 OR 1615 - 1684	
28mm	1620 - 1620 OR 1620 - 1684	

MULTIFOLD DOOR SYSTEM DOUBLE BEADED			
GLASS THICKNESS	SPECIFIC PROFILES REQUIRED	WEDGE REQUIRED	POCKET SIZE
6mm	TJ202 bead	1615 - 1933	16.75mm
12mm		1630 - 1630	
24mm	TJ227 bead	1615 - 1615	35.1mm
26mm		1615 - 1933	
28mm		1620 - 1620	



1615



1620



1625



1630



1933



1635







1651

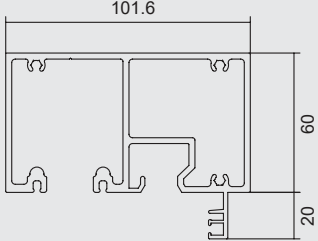

1684

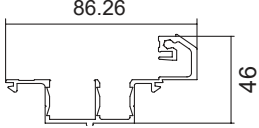
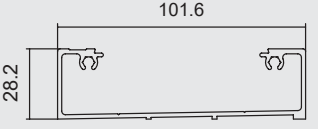
# STANDARD FLUSHBOLT MULTIFOLD DOOR

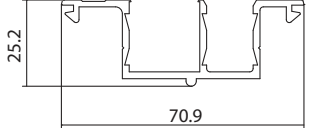





CODE	DESCRIPTION	LGTH	FINISH	GROUP ID	
HV039	60mm Head  1066, 1681	6.5m	M/F CL/ANOD	10501 10502	
HV034	Reversible Sill Insert Fits with HV035  1066, 1681, 1680-H	6.5m	M/F CL/ANOD	10501 10502	
HV035	Sill Base Slotted Fits with HV034/037	6.5m	M/F CL/ANOD	10501 10502	
HV037	Flat Reversible Sill Fits with HV035  1680-H	6.5m	M/F CL/ANOD	10501 10502	

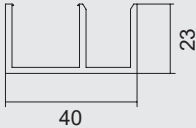

 Key hardware.

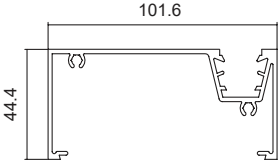

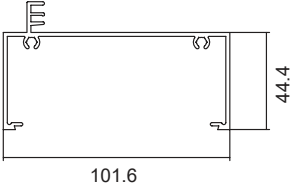





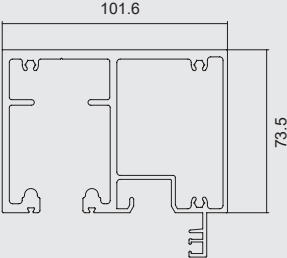
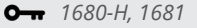
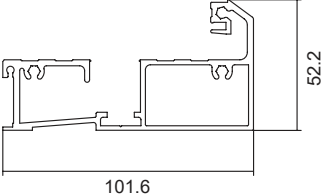

# STANDARD FLUSHBOLT MULTIFOLD DOOR

	CODE	DESCRIPTION	LGTH.	FINISH	GROUP ID
	HV036	In-Ground Channel  1066, 1680-H	6.5m	M/F CL/ANOD	10501 10502
	HV030	Snap In Jamb Fits with HV031	6.5m	M/F CL/ANOD	10501 10502
	HV031	Snap In Door Stop Fits with HV030  1681	6.5m	M/F CL/ANOD	10501 10502
	HV005-N	Jamb  1681	2.8m	M/F CL/ANOD	10501 10502
6.5m			M/F CL/ANOD	10501 10502	

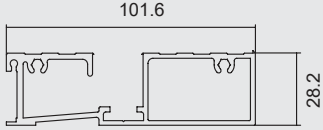
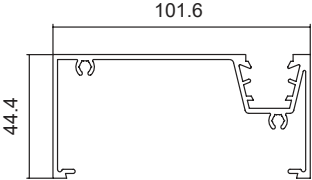

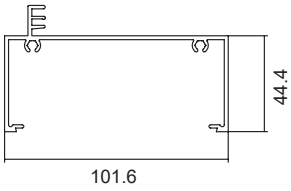

  Key hardware.

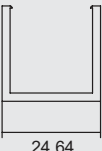
# BRIO FLUSHBOLT MULTIFOLD DOOR

CODE	DESCRIPTION	LGTH.	FINISH	GROUP ID	
HV009	One Piece Head Track  1681	6.5m	M/F CL/ANOD	10501 10502	
HV004	Sill (Slotted)  1680-H, 1681	6.5m	M/F CL/ANOD	10501 10502	
HV006	Flat Sill (Slotted)  1680-H	6.5m	M/F CL/ANOD	10501 10502	
HV030	Snap In Jamb Fits with HV031	6.5m	M/F CL/ANOD	10501 10502	
HV031	Snap In Door Stop Fits with HV030  1681	6.5m	M/F CL/ANOD	10501 10502	
HV005-N	Jamb  1681	2.8m	M/F CL/ANOD	10501 10502	
		6.5m	M/F CL/ANOD	10501 10502	
HV010	In-Ground Channel  1680-H	6.5m	M/F CL/ANOD	10501 10502	

 Key hardware.

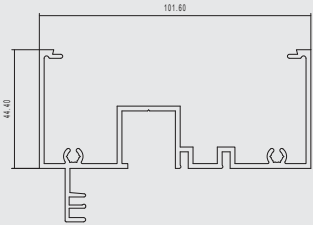
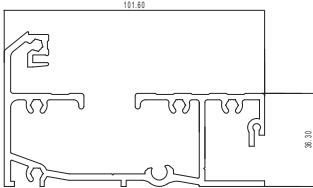
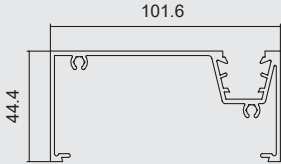





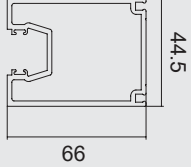

# BRIO BOTTOM ROLLING MULTIFOLD DOOR

	CODE	DESCRIPTION	LGTH.	FINISH	GROUP ID
	HV401	HarbourView Bottom Rolling Head <span>🔑 1681</span>	6.5m	M/F CL/ANOD	10501 10502
	HV402	HarbourView Bottom Rolling Sill <span>🔑 1699, 1699-Grub, 1685, 1683</span>	6.5m	M/F CL/ANOD	10501 10502
	HV30	Snap In Jamb Fits with HV031	6.5m	M/F CL/ANOD	10501 10502
	HV031	Snap In Door Stop Fits with HV030 <span>🔑 1681</span>	6.5m	M/F CL/ANOD	10501 10502

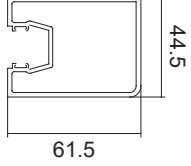

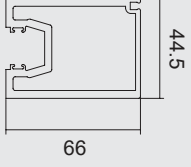

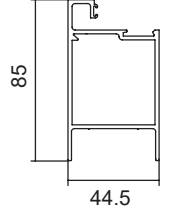

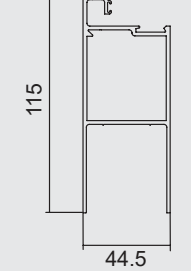
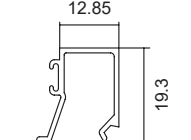







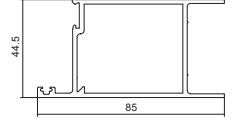

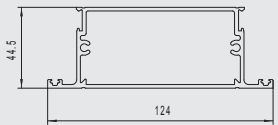

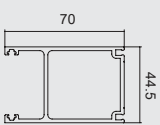
 Key hardware.

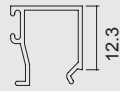
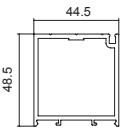
# SINGLE GLAZED MULTIFOLD DOOR

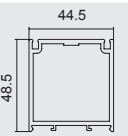
CODE	DESCRIPTION	LGTH.	FINISH	GROUP ID	
HV271	Door Stile Fits with HV273/289  1682, 1825	2.8m	M/F CL/ANOD	10501 10502	
		6.5m	M/F CL/ANOD	10501 10502	
HV272	Hinge Stile Fits with HV273/289  1825	6.5m	M/F CL/ANOD	10501 10502	
HV281	Heavy Duty Door Stile Fits with HV273/289  1682, 1825	6.5m	M/F CL/ANOD	10501 10502	
HV289	Small Rail Fits with HV271/272/274/281  1825	6.5m	M/F CL/ANOD	10501 10502	
HV273	Large Rail Fits with HV271/272/274/281  1825	6.5m	M/F CL/ANOD	10501 10502	
HV274	Door Bead Fits with HV273/289	6.5m	M/F CL/ANOD	10501 10502	

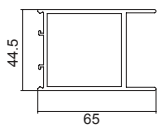
 Key hardware.

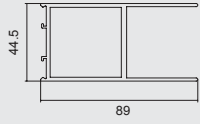
# DOUBLE GLAZED MULTIFOLD DOOR

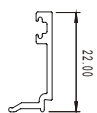
	CODE	DESCRIPTION	LGTH.	FINISH	GROUP ID
	HV275	Double Glazed Multifold Large Rail Fits with HV276/291  1826	6.5m	M/F CL/ANOD	10501 10502
	HV277	HV Small Double Glazed Rail Fits with HV276/291  1826	6.5m	M/F CL/ANOD	10501 10502
	HV278	124mm Double Glazed Mid Rail Fits with HV276/291	6.5m	M/F CL/ANOD	10501 10502
	HV276	Double Glazed Multifold Bead Fits with HV275/277/278	6.5m	M/F CL/ANOD	10501 10502
	HV291	Double Glazed Multifold Stile Fits with HV275/277  1826, 1682	6.5m	M/F CL/ANOD	10501 10502
	CODE	DESCRIPTION	LGTH.	FINISH	GROUP ID
	TJ202	Door Bead Fits with TJ200/201/204/210/211/226	6.5m	M/F CL/ANOD	9501 9502
	TJ220	Multifold Door Stile Fits with TJ202/227  1820, 2590, 2600, 2610, 2620	6.5m	M/F CL/ANOD	9501 9502
	TJ211	Multifold Door Stile Fits with TJ203/207/227  1682, 1820	6.5m	M/F CL/ANOD	9501 9502
	TJ207	Small Rail Fits with TJ211/227  1820	6.5m	M/F CL/ANOD	9501 9502
	TJ203	Large Rail Fits with TJ211/227  1820	6.5m	M/F CL/ANOD	9501 9502
	TJ227	Double Glazed Bead Fits with TJ211/207/203	6.5m	M/F CL/ANOD	9501 9502

 Key hardware.

# TOP ROLLING MULTIFOLD DOOR HARDWARE

CODE	DESCRIPTION	U.O.M.	BOX QTY.	GROUP ID	
15300	Hinge Set to Suit Multifold Door HEN3 with Handle	Set	1	16101	
15500	Hinge Set to Suit Multifold Door HEN5-H	Set	1	16101	
15600	Hinge Set to Suit Multifold Door HEN6-H	Set	1	16101	
15700	Hinge Set to Suit Multifold Door HEN7 with Handle	Set	1	16101	
15100	Pivot Set 100kg - SS	Set	1	16101	
15250	End Hanger Set 50kg - SS	Set	1	16101	
15275	End Hanger Set 100kg - SS	Set	1	16101	
15475	Intermediate Hanger Set 100kg - SS	Set	1	16101	
15445	Intermediate Hanger Set 50kg - SS	Set	1	16101	

# BOTTOM ROLLING MULTIFOLD DOOR HARDWARE

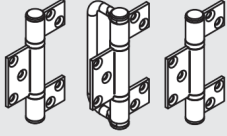
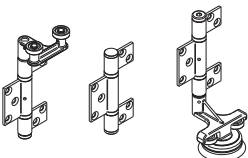
	CODE	DESCRIPTION	U.O.M.	BOX QTY.	GROUP ID
	15300	Hinge Set to Suit Multifold Door HEN3 with Handle	Set	1	16101
	15500	Hinge Set to Suit Multifold Door HEN5-H	Set	1	16101
	15600	Hinge Set to Suit Multifold Door HEN6-H	Set	1	16101
	15700	Hinge Set to Suit Multifold Door HEN7 with Handle	Set	1	16101
	15800	Bottom Rolling Pivot Set - 80kg	Set	1	16101
	15801	Bottom Rolling End Guide Set - Left Hand - 80kg	Set	1	16101
	15802	Bottom Rolling End Guide Set - Right Hand - 80kg	Set	1	16101
	15803	Bottom Rolling Intermediate Guide Set - 80kg	Set	1	16101
	1699	6mm 304 SS Rod, 6 metre	Each	N/A	16101
	1699-Grub	Grub Screw 1/4" X 1/2" UNC CUP PNT	Each	N/A	16101

# MULTIFOLD DOOR HARDWARE

CODE	DESCRIPTION	U.O.M.	BOX QTY.	GROUP ID	
15401	Flush Pull-SS	Each	1	16101	
15124	BRIO Multifold Flushbolt Non-Locking 400mm-SS	Each	1	16101	
15126	BRIO Multifold Flushbolt Non-Locking 600mm-SS	Each	1	16101	
15129	BRIO Multifold Flushbolt Non-Locking 900mm-SS	Each	1	16101	
15124L	BRIO Multifold Flushbolt Locking 400mm-SS	Each	1	16101	
15126L	BRIO Multifold Flushbolt Locking 600mm-SS	Each	1	16101	
15129L	BRIO Multifold Flushbolt Locking 900mm-SS	Each	1	16101	
					
15130	BRIO Flushbolt Surround SSS To Suit 512 Flushbolt (15124 to 15129)	Each	1	16101	
1820	Spigots for Double Beaded Door Set of 4 Includes Bolts Suits TJ211/203/207	Set	1	16153	
1825	Spigots for Multifold Door Set of 4 includes Bolts Suits HV271/272/273/281/289	Set	1	16101	
1826	Spigots to Suit Multifold Door Set of 4 with Bolts Suits HV291/275/277	Set	1	16101	



# MULTIFOLD DOOR HARDWARE

	CODE	DESCRIPTION	U.O.M.	BOX QTY.	GROUP ID
	1066-**	Flushbolt Standard - 300mm <i>**Specify finish: Black-BL, Satin Chrome-SC.</i> 	Each	10	16121
	1067-**	Flushbolt Standard - 600mm <i>**Specify finish: Satin Chrome-SC.</i> 	Each	10	16121
	1066-ROD600	Flushbolt Extension Rod Only 600mm Suits 1066	Each	1	16201
	1066-ROD900	Flushbolt Extension Rod Only 900mm Suits 1066	Each	1	16201
	1068	Floor Ferule to Suit 1066/1067 Flushbolt Stainless Steel	Each	1	16121
	1055-FBB	Flushbolt Block Suits HV271 with Standard Flushbolt	Each	N/A	16101
	15141	Brio 286 Dual Point Lock Body	Each	1	16101
	15142-SSS	Brio 286 Dual Point Non-Locking Handle Satin Stainless Steel	Each	1	16101
	15142-Z-BL	Brio 286 Dual Point Non-Locking Handle Zinc - Black Powder Coated	Each	1	16101
	15143-SSS	Brio 286 Dual Point Locking Handle Satin Stainless Steel	Each	1	16101
	15143-Z-BL	Brio 286 Dual Point Locking Handle Zinc - Black Powder-coated.	Each	1	16101
	15142-SSS-SK	Brio 286 Dual Point Kit 2.5m, Non-Locking - Satin Stainless Steel	Each	1	16101
	15142-ZBL-SK	Brio 286 Dual Point Kit 2.5m, Non-Locking, Zinc - Black PC	Each	1	16101
	15142-ZSN-SK	Brio 286 Dual Point Kit 2.5m, Non-Locking, Zinc - Satin Nickel	Each	1	16101
	15142-SN-SK35	Brio 286 Dual Point Kit 3.5m, Non-Locking - Satin Nickel	Each	1	16101
	15142-SSS-SK35	Brio 286 Dual Point Kit 3.5m, Non-Locking - Satin Stainless Steel	Each	1	16101
	15143-SSS-SK	Brio 286 Dual Point Kit 2.5m, Locking - Satin Stainless Steel	Each	1	16101
	15143-ZBL-SK	Brio 286 Dual Point Kit 2.5m, Locking, Zinc - Black PC	Each	1	16101
	15143-ZSN-SK	Brio 286 Dual Point Kit 2.5m, Locking, Zinc - Satin Nickel	Each	1	16101
	15143-SN-SK	Brio 286 Dual Point Kit 2.5m, Locking - Satin Nickel	Each	1	16101



Please check with your local branch for stock availability.

# MULTIFOLD DOOR HARDWARE

CODE	DESCRIPTION		U.O.M.	BOX QTY.	GROUP ID	
15144A	Brio 286 Dual Point Rod Pack 1.3m to 2.9m - SS D-Tip	TBA R&D	Each	1	16101	
15144B	Brio 286 Dual Point Rod Pack 2.91m to 3.9m - SS D-Tip	TBA R&D	Each	1	16101	
15131	Twin Point Multifold Lock No Cylinder - Black		Set	10	16101	
15132	Twin Point Multifold Lock No Cylinder - Satin Chrome		Set	10	16101	
15133	Twin Point Multifold Lock with Cylinder Black		Set	10	16101	
15134	Twin Point Multifold Lock with Cylinder Satin Chrome		Set	10	16101	
15137	Extension Rod (2700mm High Doors) Suits 15131/15132		Set	10	16101	
15138	Rod Joiner Fits with 15137		Set	10	16101	
15144A	Brio 286 Dual Point Rod Pack - 1.3m to 2.5m		Each	N/A	16101	
15144B	Brio 286 Dual Point Rod Pack - 2.5m to 3.5m		Each	N/A	16101	
1141	Optimum 2 Point Lock Body Only - 30mm Backset (Cylinder Not Included)		Each	10	16129	
1147	Palladium Handle - Black Suits 1141 Lock		Set	10	16129	
1148	Palladium Handle - Satin Pearl Suits 1141 Lock		Set	10	16129	
1142	Palladium "Xtra" Handle Entrance Set - Black To Fit with 1141		Each	10	16129	
1143	Palladium "Xtra" Handle Entrance Set - Satin Chrome to Fit with 1141		Each	10	16129	
1153	Optimum / Palladium Kits - Black (1141 Lock & Striker, 1147) No Cylinder		Set	10	16129	
1154	Optimum / Palladium Kits - Satin Chrome (1141 Lock & Striker, 1148) No Cylinder		Set	10	16129	

# MULTIFOLD DOOR HARDWARE

	CODE	DESCRIPTION	U.O.M.	BOX QTY.	GROUP ID
	1144	Euro Cylinder - 5 Pin/70mm Keyed Alike Suits with 1141 Lock	Each	10	16129
	1145	Euro Cylinder - 5 Pin/60mm Keyed To Differ Suits with 1141 Lock	Each	10	16129
	1146	Economy Euro Cylinder - 5 Pin/60mm Keyed Alike Suits 1141 Lock Lock	Each	10	16129
	1149	Euro Cylinder - 5 Pin/Turn Key Alike Suits 1141 Lock	Each	10	16129
	1137	S/Steel Strike - Standard Suits 1141 - Optimum Lock	Each	1	16129
	1138	S/Steel Extended Multifold Strike Suits 1141 Lock	Each	1	16101
	1176	<p>Lockwood Selector 3782 Lock Kit 01 Double Cylinder Set</p> <p><i>Includes:</i></p> <ul style="list-style-type: none"> <li>• 3782SS Mortice Lock</li> <li>• 4801/70SC Lever on External Plate with Cylinder Hole</li> <li>• 4901/70SC Lever on Internal Plate with Cylinder Hole</li> <li>• Double Cylinder</li> <li>• Accessory Packets to Suit</li> </ul>	Set	10	16129
	1177	<p>Lockwood Selector 3782 Lock Kit 04 Cylinder and Turn Set</p> <p><i>Includes:</i></p> <ul style="list-style-type: none"> <li>• 3782SS Mortice Lock</li> <li>• 4801/70SC Lever on External Plate with Cylinder Hole</li> <li>• 4904/70SC Lever on Internal Plate with Turnknob</li> <li>• Cylinder</li> <li>• Turnknob Adaptor</li> <li>• Accessory Packets to Suit</li> </ul>	Set	10	16129

# MULTIFOLD DOOR HARDWARE

CODE	DESCRIPTION	U.O.M.	BOX QTY.	GROUP ID	
1178	<p>Lockwood Selector 3782 Lock Kit 05 Single Cylinder Set</p> <p><i>Includes:</i></p> <ul style="list-style-type: none"> <li>• 3782SS Mortice Lock</li> <li>• 4801/70SC Lever on External Plate with Cylinder Hole</li> <li>• 4905/70SC Lever on Internal Plain Plate</li> <li>• Cylinder</li> <li>• Accessory Packets to Suit</li> </ul>	Set	10	16129	 <p>4801/70    4904/70</p>
1175	<p>Lockwood Selector 3782SS Short Backset Mortice Lock No Cylinder Included</p>	Each	10	16129	

## dormakaba DORMAKABA SELECTOR MORTICE LOCKS & KITS, CYLINDERS

CODE	DESCRIPTION	U.O.M.	BOX QTY.	GROUP ID	
1193	<p>Dormakaba ST9212 Classroom lock kit, External Cylinder with 6400/6406/30 23mm Backset</p>	Each	N/A	16129	
1192	<p>Dormakaba ST9212 Office lock kit , Cylinder and Turn with 6400/6403/30 23mm Backset</p>	Each	N/A	16129	
1191	<p>Dormakaba ST9212 Lock Kit, Double Cylinder Entry Lock with 6400/6401/30 23mm Backset</p>	Each	N/A	16129	

# MULTIFOLD DOOR HARDWARE

	CODE	DESCRIPTION	U.O.M.	BOX QTY.	GROUP ID
	1101	Lockwood 4905/70 Internal Plate & Lever No Cylinder Hole - SCP	Each	10	16129
	1102	Lockwood 4901/70 Internal Plate & Lever with Cylinder Hole - SCP	Each	10	16129
	1103	Lockwood 4904/70 Internal Plate & Lever with Turn - SCP	Each	10	16129
	1103-ADP	Snib Adaptor Suits 1103 Furniture	Each	10	16133
	1104	Lockwood 4800 External Plate with Cylinder Hole - SCP	Each	10	16129
	1105	Lockwood 4801/70 External Plate & Lever with Cylinder Hole - SCP	Each	10	16129

# MULTIFOLD DOOR HARDWARE

CODE	DESCRIPTION	U.O.M.	BOX QTY.	GROUP ID	
1120	Cylinder Single to Suit 3582 Z - Cam** - Key to Differ	Each	20	16133	
1121	Cylinder Single to Suit 3582 Z - Cam** - Key Alike  <i>**Primary Function Outside 1105 / 1102 Inside</i>	Each	20	16133	
1122	Cylinder Single to Suit 3582 W - Cam** - Key to Differ	Each	20	16133	
1123	Cylinder Single to Suit 3582 W - Cam** - Key Alike  <i>**Cylinder &amp; Turn Function Outside 1105 / 1103 Inside</i>	Each	20	16133	
1124	Cylinder Single to Suit 3582 X - Cam** - Key to Differ	Each	20	16133	
1125	Cylinder Single to Suit 3582 X - Cam** - Key Alike  <i>**Escape Function Outside 1105 / 1101 Inside</i>	Each	20	16133	
1140	Electric Strike 12 Volt	Each	N/A	16129	
1109	Multifold Extended Strike Suit Synergy Lock + Selector & Sorrento	Each	10	16129	
1155	Sorrento Face Mount Single Point Lock <i>(Cylinder not included)</i>	Each	N/A	16129	
1159	Mortice Lock Flush Mounting Tabs Suits Sorrento 1155	Pair	N/A	16129	
1157	Lazy Cam Cylinder	Each	N/A	16129	
1156	Multi Point Accessory Pack Suits Sorrento 1155	Each	N/A	16129	

# MULTIFOLD DOOR HARDWARE

	CODE	DESCRIPTION	U.O.M.	BOX QTY.	GROUP ID
	1480	Foam Seals 470 Pairs Roll Suits HV009/001	Roll	N/A	16101
	1481	Foam Seals 590 Pairs Roll Suits HV004/006	Roll	N/A	16101
	1482	Foam Seals 1105 Pieces Roll Suits HV273/289	Roll	N/A	16101
	1612	Channel for 6mm Glass - 100m Roll Suits 35mm Door Sections (TJ380/381/382)	Roll	N/A	16169
	1615	Glazing Wedge - 200m Roll Suits Double Beaded Door (TJ202)	Roll	N/A	16169
	1620	Glazing Wedge PVC - 200m Roll	Roll	N/A	16169
	1625	Glazing Wedge PVC for 8.36mm Glass - 250m Roll	Roll	N/A	16169
	1630	Glazing Wedge PVC for 10.38mm Glass - 200m Roll	Roll	N/A	16169
	1635	Co-extruded Captive Rubber (Green) for 8.38mm Centre Glazed - 150m Roll	Roll	N/A	16169
	1651	6mm Captive Wedge for 76mm Framing - 100m Roll	Roll	N/A	16169
	1680-H	Sill Insert PVC 6.5m Black Pre-Punched Suits HV004/006/010 /034 /036	Lgth.	N/A	16101
	1681	Multifold Seal 100m Roll Suits Head / Jamb / Sill	Roll	N/A	16101
	1682	Multifold Seal - 100m Roll Suits Door Stiles	Roll	N/A	16101
	1683	Multifold Seal 100m Roll Suits High Performance	Roll	N/A	16101
	1684	Glazing Wedge Co-Extruded - 150m Roll	Roll	N/A	16169
	1685	Sill Flap / Insert - 300m Roll	Roll	N/A	16169
	1933	6mm Glazing Wedge - 125m Roll	Roll	N/A	16169
	2590	Fringe Pile 11mm x 600m Roll Black	Roll	5	6146

# MULTIFOLD DOOR HARDWARE

CODE	DESCRIPTION	U.O.M.	BOX QTY.	GROUP ID	
1370**	Dow Corning 688 Silicone Glazing & Cladding Sealant <i>688**Specify finish: Black-BL, Translucent-Trans, White-WH.</i>	Tube	24	16161	
1371**	Dow Corning 795 Structural Glazing Silicone <i>795**Specify finish: Black-BL.</i>	Sausage	20	16161	
1311**	Dow Corning 680 Sanitary Silicone - Tube (Neutral Cure) <i>680 **Specify Finish: Transparent-TR White-WH.</i>	Tube	20	16161	
1900-M	Frame Packers - 1.5mm X 90mm Blue 100/Bag	Bag	N/A	16157	
1901-M	Frame Packers - 3mm X 90mm Green 100/Bag	Bag	N/A	16157	
1902-M	Frame Packers - 5mm X 90mm Orchre 100/Bag	Bag	N/A	16157	
1903-M	Frame Packers - 10mm X 90mm Black 100/Bag	Bag	N/A	16157	
1910	Setting Blocks 3mm Thick	Bag	N/A	16157	
1911	Setting Blocks 5mm Thick	Bag	N/A	16157	
1912	Setting Blocks 10mm Thick	Bag	N/A	16157	
1977	Setting Blocks 5mm X 25mm - 3m Self Adhesive	Bag	N/A	17320	
1978	Setting Blocks 10mm X 25mm - 3m Self Adhesive	Bag	N/A	17320	
1979	Setting Blocks 3mm X 10mm X 25mm - 3m Double Sided Tape	Bag	N/A	17320	
1930	End Cap to Suit Subsills Bag of 50 Pairs - Left + Right	Bag	N/A	16157	
1960	Lanotec General Purpose Liquid Lanolin 400g	Tube	12	16181	
1961	Lanotec "Citra Force" Cleaner Degreaser 400g	Tube	12	16181	

 Please check with your local branch for stock availability.



# SYSTEM TOOLING

**CODE**      **DESCRIPTION**



DTL3109      45mm Door Press  
-AIR      Suits TJ154/155/158/159/321/322/327/311/312/313/315  
                 HV271/273/281/289

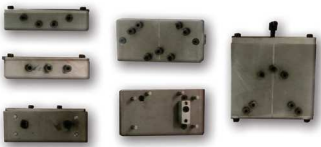

DTL3123      Drill Jigs Bi-fold



# SPECIAL FEATURE



## DARLEY VICTORIA NOW OFFERING TIMBER REVEALS

Your one-stop-shop for all your aluminium window & door needs



We are pleased to announce that you can now order timber reveals cut to size with your KlassicView kits.

Darley's NEW timber reveals are:

- 138mm wide primed ALBASA timber
- Available cut to size to suit your kit order or in 5.8m lengths
- Made using a finger jointed laminating process
- Adhere to Australian standards with regards to shrinkage, moisture and warping of timber
- Responsibly sourced from timber plantations
- The new *Inline Reveal Adaptor* is also available to compliment the KlassicView line

**TO ORDER your timber reveals go to:** [www.darleyaluminium.com.au/Products/Order-Online](http://www.darleyaluminium.com.au/Products/Order-Online)



**PATIO DOOR SYSTEM**



**101.6MM SLIDING WINDOW  
PATIO DOOR  
(INCLUDING SINGLE PIECE INTERLOCK)**

GLASS THICKNESS	CHANNEL RUBBER REQUIRED	POCKET SIZE
6mm	1670	12.5mm
8mm	1604	
10mm	1671	
12mm	1666	
16mm	1689	21.5mm
18mm	1667	
20mm	1677	
20.4mm	1661	



1604



1661



1666



1670



1667



1671









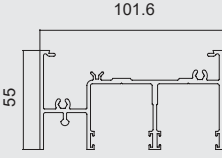

1677

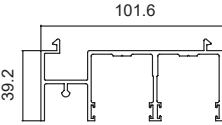

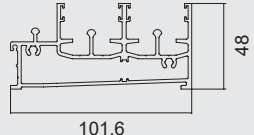
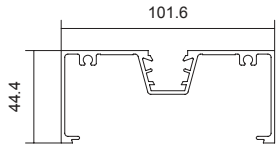

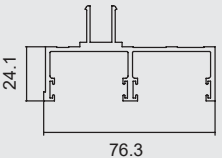
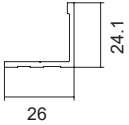
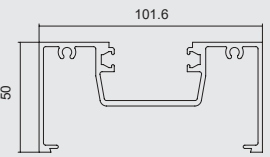

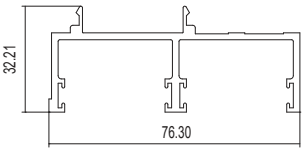
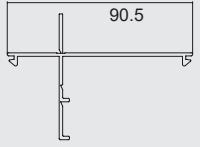





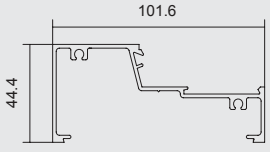
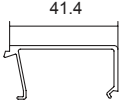
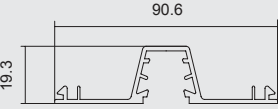
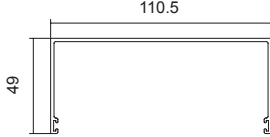

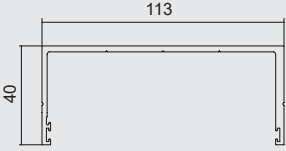
1689

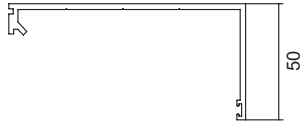
# 101.6MM PATIO DOOR

CODE	DESCRIPTION	LGTH.	FINISH	GROUP ID	
SWD411	Patio Sliding Door Head Fits with SWD416  1488, 1721	6.5m	M/F CL/ANOD	10801 10802	
SWD412	Patio Sliding Door Snap In Head Fits with TJ302  1721	6.5m	M/F CL/ANOD	10801 10802	
SWD413	Patio Sliding Door Closed Sill- Slotted  1489, FB1225, 1721, 1685	6.5m	M/F CL/ANOD	10801 10802	
TJ301	Standard Main Frame Fits with TJ304/305/306/TJ307/342/ SWD414/SW017/018	6.5m	M/F CL/ANOD	8301 8302	
SWD414	Patio Sliding Door Receiver Fits with TJ301  1721	5.4m	M/F CL/ANOD	10801 10802	
SWD415	Patio Sliding Door Flyscreen Receiver Fits with SWD414	5.4m	M/F CL/ANOD	10801 10802	
CDG4301	Frame Fits with CDG4304/4307/CDG4308/4316/ DGF4506	6.5m	M/F CL/ANOD	8401 8402	
SWD036	Patio Door Receiver Channel To Suit 101.6mm CDG  1721	5.4m 5.4m	M/F CL/ANOD	10801 10802	
SWD416	Patio Door Reveal Adaptor Fits with SWD411/TJ301/SWD610/SWD611	6.5m	M/F CL/ANOD	10801 10802	

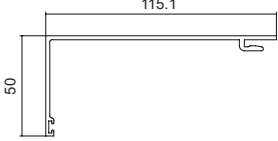

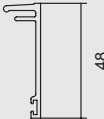







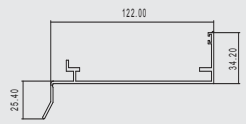

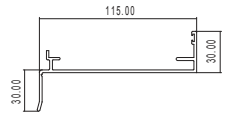

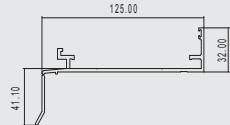
 Key hardware.

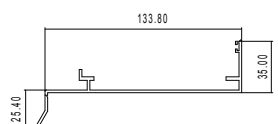
# 101.6MM PATIO DOOR

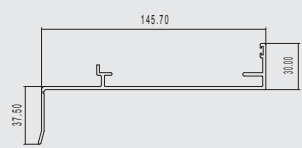
	CODE	DESCRIPTION	LGTH.	FINISH	GROUP ID
	TJ302	Sill Transom Fits with TJ303/304/305	6.5m	M/F CL/ANOD BZ/ANOD	8301 8302 8301
	TJ303	Sill Bead Fits with TJ302	6.5m	M/F CL/ANOD BZ/ANOD	8301 8302 8301
	TJ304	Glazing Adaptor Fits with TJ301/302/306/307/ TJ308/335/6151/6152	6.5m	M/F CL/ANOD BZ/ANOD	8301 8302 8301
	TJ309	49mm Sub Head  1601,1710	6.5m	M/F CL/ANOD BZ/ANOD	10001 10002 10001
	TJ399	Heavy Duty Sub Head  1601,1710	6.5m	M/F CL/ANOD	10001 10002
	TJ430	Two Part Sub Head Fits with TJ429  1601	6.5m	M/F CL/ANOD	10001 10002
	TJ429	Sub Head Cover Fits with TJ430  1601	6.5m	M/F CL/ANOD	10001 10002
	TJ431	Sub Head / Jamb  1601	6.5m	M/F CL/ANOD	10001 10002
	TJ6159	Sub Head / Jamb Cover Fits with TJ431  1601	6.5m	M/F CL/ANOD	10001 10002

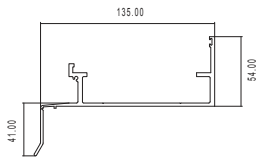
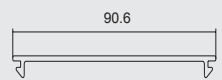
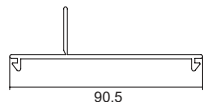
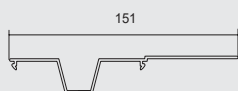
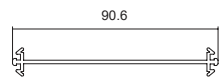
 Key hardware.

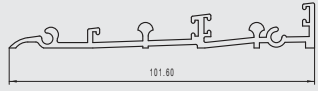

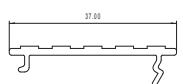





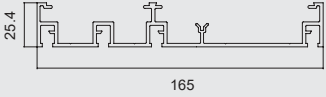
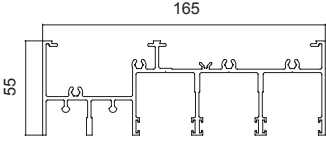

# 101.6MM PATIO DOOR

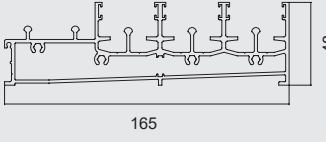
CODE	DESCRIPTION	LGTH.	FINISH	GROUP ID	
TJ359	Light Duty Sub Sill 12mm Set Back Slotted  1601,1930	6.5m	M/F CL/ANOD BZ/ANOD	10001 10002 10001	
TJ368	STD Sub Sill 6mm Set Back Slotted  1601,1930	6.5m	M/F CL/ANOD	10001 10002	
TJ379	Heavy Duty Sub Sill 12mm Set Back Slotted  1601,1930	6.5m	M/F CL/ANOD	10001 10002	
TJ259	Sub Sill 25mm Set Back Slotted  1601,1930	6.5m	M/F CL/ANOD BZ/ANOD	10001 10002 10001	
TJ432	Sub Sill 35mm Set Back Slotted  1601,1930	6.5m	M/F CL/ANOD	10001 10002	
TJ479	High Performance Sub Sill 22mm Set Back Slotted  1601	6.5m	M/F CL/ANOD	10001 10002	
TJ305	Flush Adaptor Fits with TJ301/302	6.5m	M/F CL/ANOD BZ/ANOD	8301 8302 8301	
TJ342	Reveal Clip-In Fits with TJ301/302	6.5m	M/F CL/ANOD	8301 8302	
TJ345	Fixing Adaptor Fits with TJ301	5.4m	M/F	8301	
TJ385	Back to Back Adaptor	6.5m	M/F	8301	
SWD417	Disability Sill No Water Rating 	6.5m	M/F CL/ANOD	10802	
SWD418	Disability Threshold Cap 	6.5m	M/F CL/ANOD	10802	

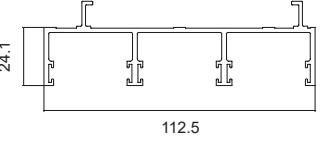
 Key hardware.

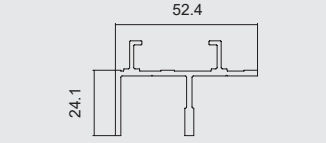
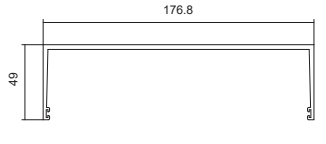
 Wheelchair access friendly

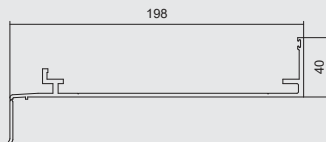
# 165MM PATIO DOOR

	CODE	DESCRIPTION	LGTH.	FINISH	GROUP ID
	SWD610	165mm Patio Door Jamb Fits with SWD416/614/615 Flat Fillers TJ305/FGS417	5.4m	M/F CL/ANOD	10801 10802
	SWD611	165mm Patio Door Head Fits with SWD416 Flat Fillers TJ305/FGS417  1490, 1721	6.5m	M/F CL/ANOD	10801 10802
	SWD613	165mm Patio Door Sill (Slotted)  1491, 1721, FB1225, 1685 	6.5m	M/F CL/ANOD	10801 10802
	SWD614	165mm Patio Door Receiver Fits with SWD610  1721	5.4m	M/F CL/ANOD	10801 10802
	SWD615	165mm Patio Door Flyscreen Receiver Channel Fits with SWD610	5.4m	M/F CL/ANOD	10801 10802
	SWD621	165mm Patio Door Sub Head  1710, 1601	6.5m	M/F CL/ANOD	10801 10802
	SWD622	165mm Patio Door Subsill  1601	6.5m	M/F CL/ANOD	10801 10802

 Key hardware.

 Technical guidance recommended.







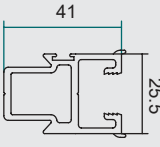

# PATIO DOOR SECTIONS

CODE	DESCRIPTION	LGTH.	FINISH	GROUP ID	
SW016	STD Interlock Fits with SW009/010/027  1672, 1830	4.6m	M/F CL/ANOD	10601 10602	
		5.4m	M/F CL/ANOD	10601 10602	
SW014	Small Box Interlock Fits with SW009/010/027  1672, 1831	4.6m	M/F CL/ANOD	10601 10602	
		5.4m	M/F CL/ANOD	10801 10802	
SW015	Large Box Interlock Fits with SW009/010/027  1672, 1832	4.6m	M/F CL/ANOD	10601 10602	
		5.4m	M/F CL/ANOD	10801 10802	
SWD030	Patio Door Heavy Duty Interlock Fits with SW009/010/027  1672, 1838	5.4m	M/F CL/ANOD	10801 10802	
SW019	Threshold Fits with SWD413/613  1837	5.3m	M/F CL/ANOD	10601 10602	
		6.5m	M/F CL/ANOD	10801 10802	
SWD033	Patio Door Threshold	6.5m	M/F CL/ANOD	10801 10802	

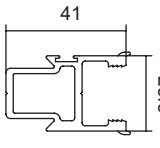
 Key hardware.

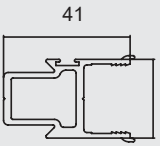

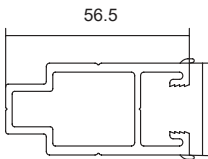
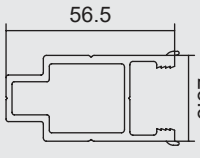
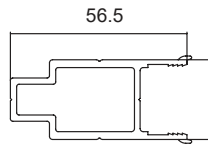
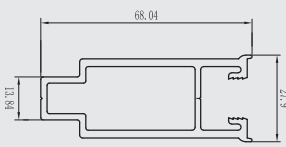
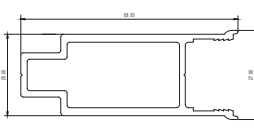
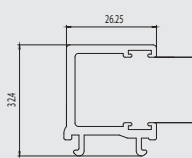
# PATIO DOOR SECTIONS

	CODE	DESCRIPTION	LGTH.	FINISH	GROUP ID
	SW009	Patio Door Interlock Stile Fits with SW014/015/016/SWD030 Suits up to 10mm Glass  1721	4.6m	M/F CL/ANOD	10601 10602
			5.4m		
	SW010	Patio Door Interlock Stile Fits with SW014/015/016/SWD030 Suits up to 16mm Glass  1721	4.6m	M/F CL/ANOD	10601 10602
			5.4m		
	SW027	Patio Door 20mm Double Glazed Interlock Stile Fits with SW014/015/016/SWD030 Suits up to 20mm Glass  1721	5.4m	M/F CL/ANOD	10801 10802
	SW022	Patio Door Male Stile Suits up to 10mm Glass	4.6m	M/F CL/ANOD	10601 10602
	SW023	Patio Door Male Stile Suits up to 16mm Glass	4.6m	M/F CL/ANOD	10601 10602
	SW029	Patio Door Male Stile Suits up to 20mm Glass	5.4m	M/F CL/ANOD	10801 10802
	SWD044	Patio Corner Stile - Male	5.4m	M/F	10801
	SWD045	Patio Corner D/G Stile - Male	4.5m	M/F	10801
	SWD623	Corner Meeting Stile  1842	5.4m	M/F	10801

 Key hardware.

# PATIO DOOR SECTIONS

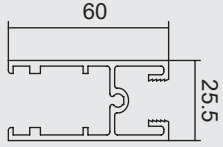
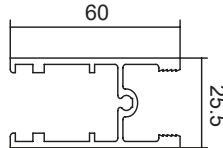
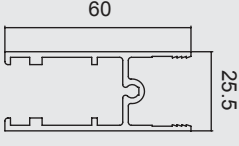
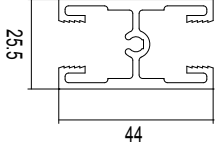
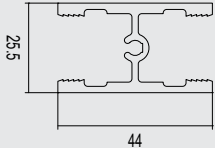
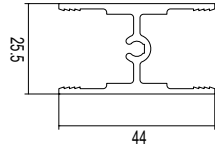
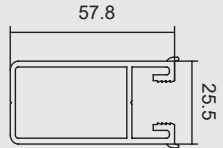
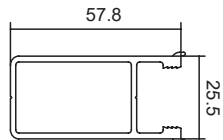





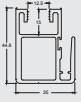

CODE	DESCRIPTION	LGTH.	FINISH	GROUP ID	
SW007	Patio Door Rail Suits up to 10mm Glass	5.3m	M/F CL/ANOD	10601 10602	
SW008	Patio Door Rail Suits up to 16mm Glass	5.3m	M/F CL/ANOD	10601 10602	
SW026	Patio Door Rail Suits up to 20mm Glass	6.5m	M/F CL/ANOD	10801 10802	
SWD041	Patio Door Standard Midrail	6.5m 6.5m	M/F CL/ANOD	10801 10802	
SWD042	Patio Door Standard Midrail Suits up to 16mm Glass	6.5m 6.5m	M/F CL/ANOD	10801 10802	
SWD043	Patio Door Standard Midrail Suits up to 20mm Glass	6.5m 6.5m	M/F CL/ANOD	10801 10802	
SW011	Patio Door Lock Stile Suits up to 10mm Glass	4.6m 5.4m	M/F CL/ANOD	10601 10602	
SW012	Patio Door Lock Stile Suits up to 16mm Glass	4.6m 5.4m	M/F CL/ANOD	10601 10602	

# PATIO DOOR SECTIONS

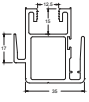

	CODE	DESCRIPTION	LGTH.	FINISH	GROUP ID
	SW028	Patio Door Lock Stile Suits up to 20mm Glass	5.4m	M/F CL/ANOD	10801 10802
	SW024	Female Adaptor Fits with SW009/SW010 1721	4.6m	M/F CL/ANOD	10601 10602
			5.4m	M/F CL/ANOD	10801 10802
	SWD031	Patio Door Heavy Duty Female Adaptor Fits with SW009/SW010 Accepts SW022/023/029 1721, 1839	5.4m	M/F CL/ANOD	10801 10802
	SWD032	Patio Door Medium Duty Female Adaptor Fits with SW009/SW010 Accepts SW022/023/029 1721, 1839	5.4m	M/F CL/ANOD	10801 10802
	SWD039	Patio Door FSF Adaptor Fits with SW009 1721, 1840	5.4m	M/F	10801
			5.4m	CL/ANOD	10802
	SWD038	Patio Door STD Interlock W' Flydoor Interlock Attached Fits with SW009 1672	5.4m	M/F	10801
			5.4m	CL/ANOD	10802
	SWD037	Patio Door Fly Door Interlock Fits with DF001 1675	5.4m	M/F	10801
			5.4m	CL/ANOD	10802
	SWD419	Patio Door Fly Door Raised Clip-on Track	6.5m	M/F CL/ANOD	10801 10802
	SWD619	Patio Door Fly Door Raised Clip-on Twin Track	6.5m	M/F CL/ANOD	10801 10802

Key hardware.

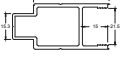
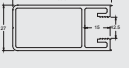
# PATIO DOOR SECTIONS - SINGLE PIECE





CODE	DESCRIPTION	U.O.M.	BOX QTY.	GROUP ID		
SWD050	Single Interlock Stile  1672, 1847, 1848	5.4m	M/F CL/ANOD	10802		
SWD051	Single Interlock with Fly Stiles  1672, 1847, 1848	5.4m	M/F CL/ANOD	10802		
SWD052	Single Interlock Box Stiles  1672, 1847, 1848, 1849	5.4m	M/F CL/ANOD	10802		
SWD053	Single Interlock Heavy Duty Box Stiles  1672, 1847, 1848, 1849	5.4m	M/F CL/ANOD	10802		
SWD060	Double Glazed Single Interlock Stiles  1672, 1847, 1848	5.4m	M/F CL/ANOD	10802		
SWD061	Double Glazed Single Interlock with Fly Stiles  1672, 1847, 1848	5.4m	M/F CL/ANOD	10802		
SWD062	Double Glazed Single Interlock Box Stiles  1672, 1847, 1848, 1849	5.4m	M/F CL/ANOD	10802		
SWD063	Double Glazed Single Interlock Heavy Duty Box Stiles  1672, 1847, 1848, 1849	5.4m	M/F CL/ANOD	10802		
SWD055	Single Glazed H/D Female Adapter  1672, 1849	5.4m	M/F CL/ANOD	10802		
SWD065	Double Glazed H/D Female Adapter  1672, 1849	5.4m	M/F CL/ANOD	10802		
SWD057	Male Stile Single Glazed	5.4m	M/F CL/ANOD	10802		
SWD067	Male Stile Double Glazed	5.4m	M/F CL/ANOD	10802		
SWD056	Stile Single Glazed	5.4m	M/F CL/ANOD	10802		
SWD066	Stile Double Glazed	5.4m	M/F CL/ANOD	10802		

# PATIO DOOR HARDWARE





	CODE	DESCRIPTION	U.O.M.	BOX QTY.	GROUP ID
	1670	Glazing Channel To Suit 6.38mm Glass - 100m Roll	Roll	N/A	16169
	1671	Glazing Channel To Suit 10.38mm Glass - 100m Roll	Roll	N/A	16169
	1666	Glazing Channel To Suit 12.38mm Glass - 40m Roll	Roll	N/A	16109
	1676	Glazing Channel To Suit 16mm Glass - 100m Roll Suits SWD10/08/12/23/42	Roll	N/A	16169
	1667	Glazing Channel To suit 18mm Glass - 75m Roll	Roll	N/A	16169
	1677	Glazing Channel To Suit 20mm Glass - 80m Roll	Roll	N/A	16169
	1689	16mm Glazing Channel Suits SW027/29/26/43	Roll	N/A	16169
	1672	Interlock Cushion - 100m Roll	Roll	N/A	16169
	1685	Sill Flap / Insert - 300m Roll	Roll	N/A	16169
	1685- COEX	Sill Flap / Insert Co-Extruded - 200m Roll	Roll	1	16169
	1721	Weatherstrip 69-525 Black with Fin - 400m Roll	Roll	5	16173
	2642	Foam Seal - Slide in 500m Roll (Everton)	Roll	N/A	16177

# PATIO DOOR HARDWARE







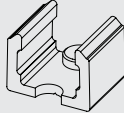
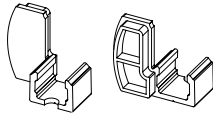
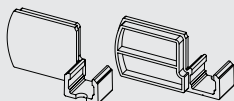

**ANTHONY INNOVATIONS** ANTHONY INNOVATIONS PATIO DOOR HARDWARE

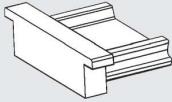
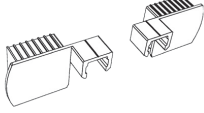
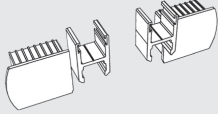
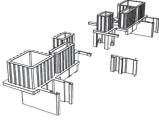
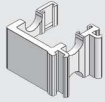
CODE	DESCRIPTION	U.O.M.	BOX QTY.	GROUP ID	
1800	Anthony Innovations 9017NA Roller for Single Wheel Patio Door - 40kg	Each	100	16149	
1801	Anthony Innovations 9017DNA Roller for Dual Wheel Patio Door - 80kg	Each	100	16149	
1802	Anthony Innovations TraXtar Duo, high performance - 110kg	Each	50	16149	
1808	Anthony Innovations Quad Roller 150kg	Each	20	16149	

## PATIO DOOR HARDWARE

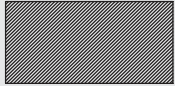
CODE	DESCRIPTION	U.O.M.	BOX QTY.	GROUP ID	
1803	Fixed Panel Adjustment Block	Each	100	16149	
1836	Fixing Clip to Suit Patio Interlock Bag of 500	Bag	N/A	16109	
1834	Hole Plug 10mm Bag of 200	Bag	N/A	16109	
1912	Setting Block / Fixed Panel Spacing Block Bag of 500	500	N/A	16157	
1830	Filler Block For SW016 Bag of 20	Bag	N/A	16109	
1831	Filler Block For SW014 Bag of 10 Pairs	Bag	N/A	16109	
1832	Filler Block For SW015 Bag of 10 Pairs	Bag	N/A	16109	

# PATIO DOOR HARDWARE

	CODE	DESCRIPTION	U.O.M.	BOX QTY.	GROUP ID
	1837	End Cap to Suit Patio Door Threshold - Black	20 pieces p/bag	N/A	16109
	1838	End Caps to Suit Patio Door Interlocks - SWD030 - Black	10 pairs p/bag	N/A	16109
	1839	End Caps to Suit Patio Door Interlocks - SWD031/032 - Black	10 pairs p/bag	N/A	16109
	1840	End Caps to Suit Patio Door Interlocks - SWD039 - Black	10 pairs p/bag	N/A	16109
	1842	Patio Corner Door Block (L & R)	10 pairs p/bag	N/A	16109
	1847	Single Interlock Fixed Panel Block SWD050/51/52/53/60/61/62/63	10 pairs p/bag	N/A	16109
	1848	Single Interlock Filler Block SWD050/51/52/53/60/61/62/63	10 pairs p/bag	N/A	16109
	1849	Single Interlock End Cap SWD052/53/55/62/63/65	10 pieces p/bag	N/A	16109
	1488	Foam Seal - 905 Pieces Roll Fits with SWD411 Head	Roll	N/A	16177
	1489	Foam Seal - 500 Pieces Roll Fits with SWD413 Sill	Roll	N/A	16177
	1490	Foam Seal - 905 Pieces Roll Fits with SWD611 Head	Roll	N/A	16177
	1491	Foam Seal - 695 Pieces Roll Fits with SWD613 Sill	Roll	N/A	16177

# PATIO DOOR HARDWARE



## LOCKWOOD ONYX & ACCESSORIES

CODE	DESCRIPTION	U.O.M.	BOX QTY.	GROUP ID
1252-**	ONYX Lock - D Inner/Slim Outer, 5 Pin Cyl - K/D, Surface Strike <i>**Specify finish: Black-BL, Silver-SCA</i>	Each	10	16149
1352-**	ONYX Lock - D Inner/Slim Outer, 5 Pin Cyl - K/N J031, Surface Strike <i>**Specify finish: Black-BL, Silver-SCA</i>	Each	10	16149
1253	ONYX Lock-D Inner/Slim Outer, 5 Pin Cyl - K/D, Surface Strike Satin Chrome	Each	10	16149
1254-**	ONYX Lock - Slim Inner/Slim Outer, 5 Pin Cyl- K/D, Surface Strike <i>**Specify finish: Black-BL, Silver-SCA</i>	Each	10	16149
1354-**	ONYX Lock - Slim Inner/Slim Outer, 5 Pin Cyl- K/N J031, Surface Strike <i>**Specify finish: Black-BL, Silver-SCA</i>	Each	10	16149
1255	ONYX Lock - Slim Inner/Slim Outer, 5 Pin Cyl- K/D, Surface Strike Satin Chrome	Each	10	16149
1256	ONYX Extra Wide Strike - Black	Each	10	16149
1257	ONYX Extra Wide Strike - Satin Chrome	Each	10	16149
1260-BL	ONYX Lock Handle Packer - Black	Each	10	16149
1260-SCA	ONYX Lock Handle Packer - Silver	Each	10	16149
1261	ONYX Lock Handle Packer - Satin Chrome	Each	10	16149



## AUSTRAL YARRA VIEW & CYLINDERS

CODE	DESCRIPTION	U.O.M.	BOX QTY.	GROUP ID
1258-**	Yarra View Edge Sliding Door Lock Need 2 Cylinders 1268 or 1269 to go with Lock <i>**Specify finish: Black-BL, Silver-SCA</i>	Each	5	16149
1358-BL	Yarra View Ridge Sliding Glass Door Deadlock - Black	Each	N/A	16149
1268	C4 5 Pin Cylinder Yarra View - K/Alike - Single Cylinder Only, Key No Is 249	Bag	10	16149
1269	C4 5 Pin Cylinder Yarra View - K/Differ - Single Cylinder Only	Bag	10	16149
1269-KAP	C4 5 Pin Cylinder Yarra View - K/Alike In Pairs for Double Cylinders Lock	Bag	5	16149



Please check with your local branch for stock availability.







# PATIO DOOR HARDWARE

 **DORIC AVANA & CYLINDERS**

	CODE	DESCRIPTION	U.O.M.	BOX QTY.	GROUP ID
 	1249	Avana Sliding Door lock includes Cylinder DS2150 Black	Each	N/A	16149
	<b>CODE</b>	<b>DESCRIPTION</b>	<b>U.O.M.</b>	<b>BOX QTY.</b>	<b>GROUP ID</b>
	1370**	Dow Corning 688 Silicone Glazing & Cladding Sealant <i>688**Specify finish: Black-BL, Translucent-Trans, White-WH.</i> 	Tube	24	16161
	1371**	Dow Corning 795 Structural Glazing Silicone <i>795**Specify finish: Black-BL.</i> 	Sausage	20	16161
	1311**	Dow Corning 680 Sanitary Silicone (Neutral Cure) <i>680**Specify finish: Transparent-TR White-WH.</i> 	Tube	20	16161
	1900-M	Frame Packers - 1.5mm X 90mm. Blue 100/Bag	Bag	N/A	16157
	1901-M	Frame Packers - 3mm X 90mm. Green 100/Bag	Bag	N/A	16157
	1902-M	Frame Packers - 5mm X 90mm. Ochre 100/Bag	Bag	N/A	16157
	1903-M	Frame Packers - 10mm X 90mm. Black 100/Bag	Bag	N/A	16157
	1910	Setting Blocks 3mm Thick	Bag	N/A	16157
	1911	Setting Blocks 5mm Thick	Bag	N/A	16157
	1912	Setting Blocks 10mm Thick	Bag	N/A	16157
	1977	Setting Blocks 5mm X 25mm - 3m Self Adhesive	Bag	N/A	17320
	1978	Setting Blocks 10mm X 25mm - 3m Self Adhesive	Bag	N/A	17320
	1979	Setting Blocks 3mm X 10mm X 25mm - 3m Double Sided Tape	Bag	N/A	17320
	1930	End Cap to Suit Subsills Bag of 50 Pairs - Left + Right	Bag	N/A	16157
	1960	Lanotec General Purpose Liquid Lanolin 400g	Tube	12	16181
	1961	Lanotec "Citra Force" Cleaner Degreaser 400g	Tube	12	16181

 Please check with your local branch for stock availability.

# SYSTEM TOOLING

CODE	DESCRIPTION	
DTL3106	101.6mm Sliding Window / Patio Door Drilling Jig Suits SW009/010/011/012/022/023	
DTL3107	Stepped Drill Bit To Suit DT3106 Jig	
DTL3110-AIR	Sliding Window / Patio Door Air Operated Tool	
DTL3112	101.6mm Patio Door Dr & Sliding Window Jamb Tool	
DTL3113	165mm Patio Door Jamb Tool	
DTL3114	101.6mm Patio Door Jamb Drill Jig Set (Head & Sill)	
DTL3115	165mm Patio Door Jamb Drill Jig Set (Head & Sill)	







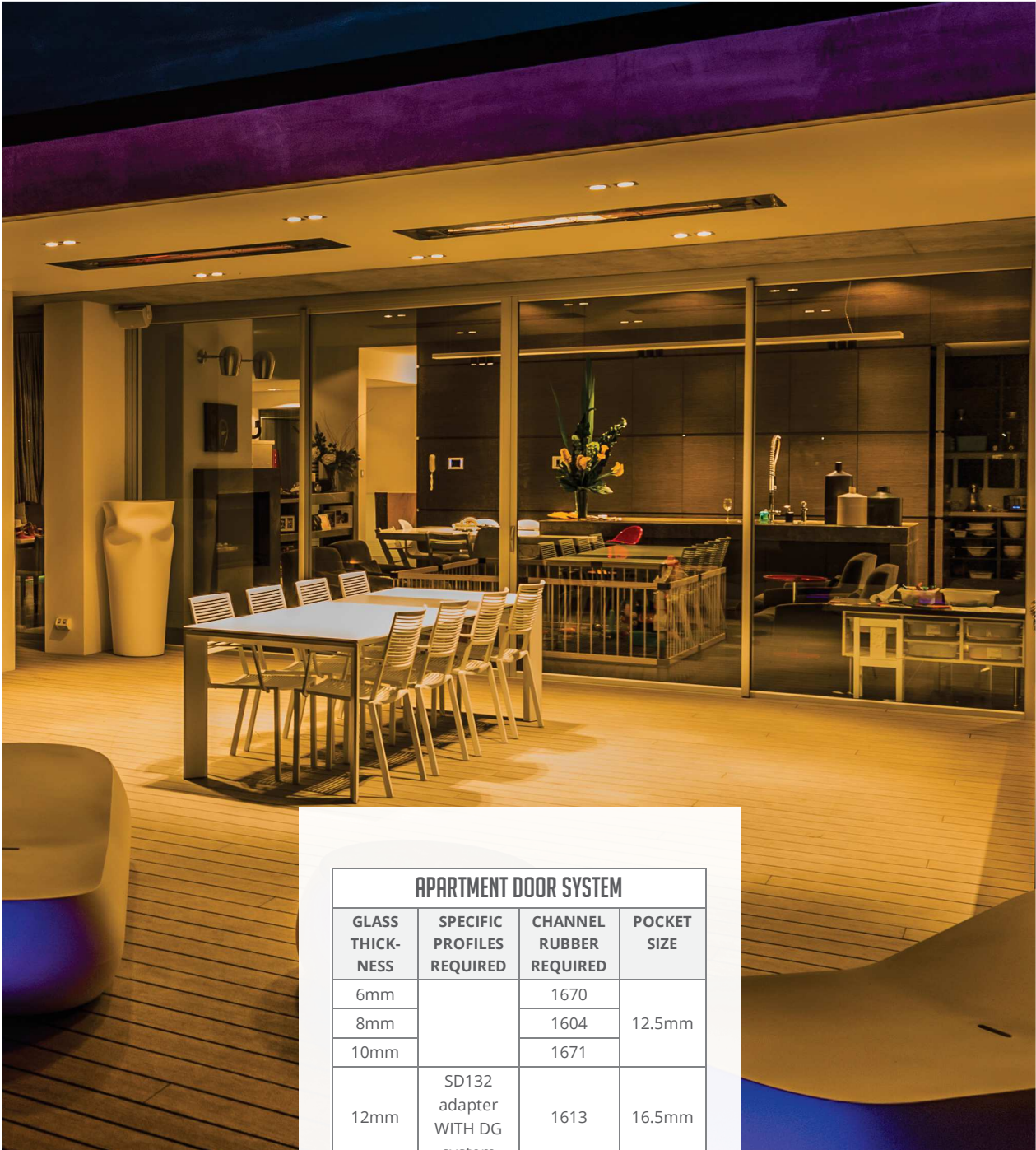

APARTMENT DOOR SYSTEM

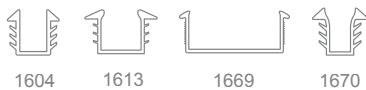

APARTMENT DOOR SYSTEM			
GLASS THICKNESS	SPECIFIC PROFILES REQUIRED	CHANNEL RUBBER REQUIRED	POCKET SIZE
6mm		1670	12.5mm
8mm		1604	
10mm		1671	
12mm	SD132 adapter WITH DG system	1613	16.5mm
24mm		1674	30mm
28mm		1669	
30mm	SD157 adapter WITH DG system	1696	33mm

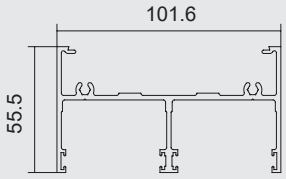

# 101.6MM APARTMENT DOOR

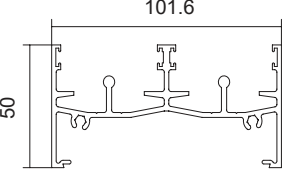
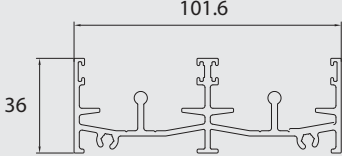
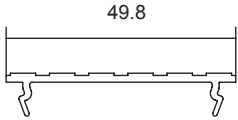
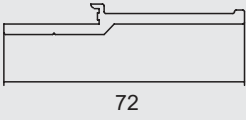



CODE	DESCRIPTION	LGTH.	FINISH	GROUP ID	
SD401	Door Head  1721, 1478	6.5m	M/F CL/ANOD	10401 10402	
SD402	Door Sill - Slotted  1721, 1478	6.5m	M/F CL/ANOD	10401 10402	
SD403	36mm Door Sill - (Not slotted)	6.5m	M/F	10401	
SD603	Universal Threshold	6.5m	M/F CL/ANOD	10401 10402	
SD469	High Performance Sill Riser Fits with SD402/602	6.5m	M/F CL/ANOD	10401 10402	

**TO BE  
DISCONTINUED**

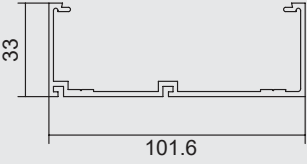
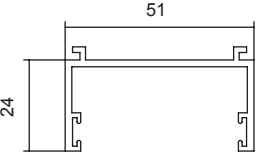

  Key hardware.

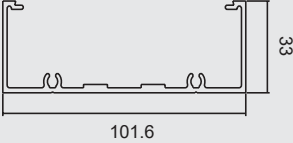
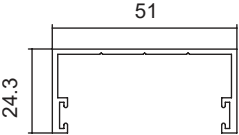

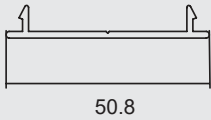





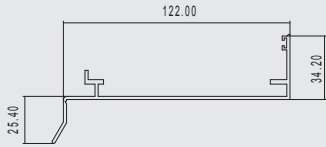

# 101.6MM APARTMENT DOOR

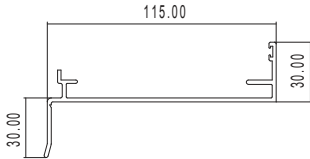
	CODE	DESCRIPTION	LGTH.	FINISH	GROUP ID
	SD400	Jamb Fits with SD468	6.5m	M/F CL/ANOD	10401 10402
	SD468	Slide In Jamb Adaptor Fits with SD400/600/800  1721	6.5m	M/F CL/ANOD	10401 10402
	SD100	101.6mm Plain Jamb	6.5m	M/F CL/ANOD	10401 10402
	SD111	Screw Fix Jamb Adaptor Fits with SD100/150  1721	6.5m	M/F CL/ANOD	10401 10402
	SD128	Head/Sill Track Filler	6.5m	M/F CL/ANOD	10401 10402

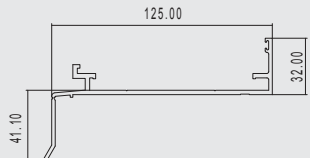

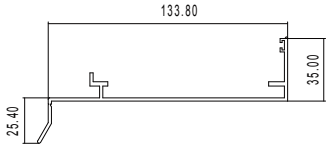
  Key hardware.

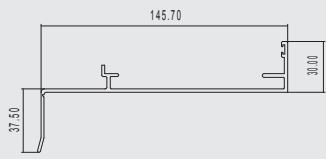
# 101.6MM APARTMENT DOOR

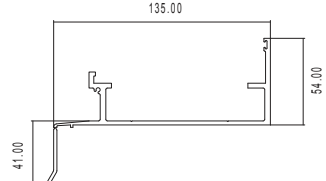







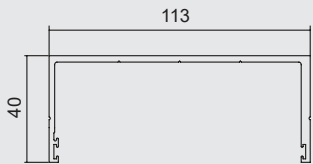

CODE	DESCRIPTION	LGTH.	FINISH	GROUP ID	
TJ359	Light Duty Sub Sill 12mm Set Back Slotted  1601,1930	6.5m	M/F CL/ANOD BZ/ANOD	10001 10002 10001	
TJ368	STD Sub Sill 6mm Set Back Slotted  1601,1930	6.5m	M/F CL/ANOD	10001 10002	
TJ379	Heavy Duty Sub Sill 12mm Set Back Slotted  1601,1930	6.5m	M/F CL/ANOD	10001 10002	
TJ259	Sub Sill 25mm Set Back Slotted  1601,1930	6.5m	M/F CL/ANOD BZ/ANOD	10001 10002 10001	
TJ432	Sub Sill 35mm Set Back Slotted  1601,1930	6.5m	M/F CL/ANOD	10001 10002	
TJ479	High Performance Sub Sill 22mm Set Back Slotted  1601 	6.5m	M/F CL/ANOD	10001 10002	

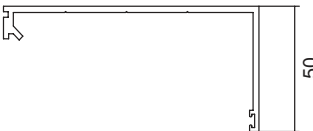

 Key hardware.

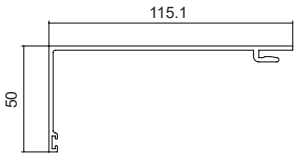
 Technical guidance recommended.

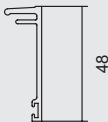
# 101.6MM APARTMENT DOOR

	CODE	DESCRIPTION	LGTH.	FINISH	GROUP ID
	TJ399	Heavy Duty Sub Head  1710, 1601	6.5m	M/F CL/ANOD	10001 10002
	TJ430	Two Part Sub Head Fits with TJ429  1601	6.5m	M/F CL/ANOD	10001 10002
	TJ429	Sub Head Cover Fits with TJ430  1601	6.5m	M/F CL/ANOD	10001 10002
	TJ431	Sub Head / Jamb Fits with TJ6159  1601	6.5m	M/F CL/ANOD	10001 10002
	TJ6159	Sub Head / Jamb Cover Fits with TJ431  1601	6.5m	M/F CL/ANOD	10001 10002



 Key hardware.

# 101.6MM APARTMENT DOOR

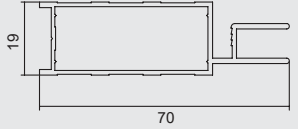
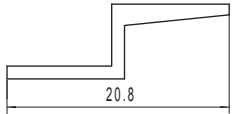
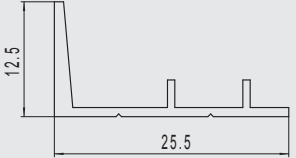
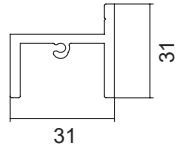
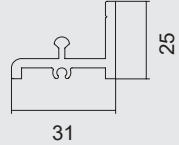
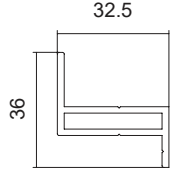
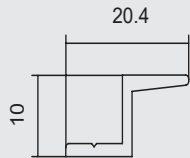
CODE	DESCRIPTION	LGTH	FINISH	GROUP ID	
DF001	Standard Security Door Frame (7mm)  2650,2651	6.0m	M/F CL/ANOD	2106 2106	
DI3224	7mm Offset Interlock	4.3m	M/F CL/ANOD	2146 2146	
DI3225	Frame Interlock	4.3m	M/F CL/ANOD	2146 2146	
SD421	Single Fly Door Head	6.5m	M/F CL/ANOD	10401 10402	
SD422	Single Fly Door Sill	6.5m	M/F CL/ANOD	10401 10402	
SD425	Single Fly Door Jamb	6.5m	M/F CL/ANOD	10401 10402	
SD626	10mm Interlock	6.5m	M/F CL/ANOD BZ/ANOD	10401 10402 10401	

 Key hardware.

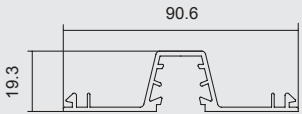
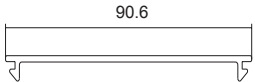
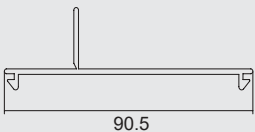
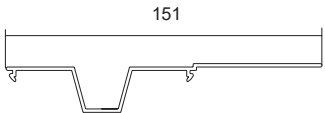
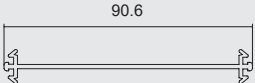
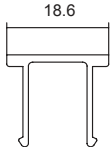

# 101.6MM APARTMENT DOOR

	CODE	DESCRIPTION	LGTH.	FINISH	GROUP ID
	TJ304	Glazing Adaptor	6.5m	M/F CL/ANOD BZ/ANOD	8301 8302 8301
	TJ305	Flush Adaptor	6.5m	M/F CL/ANOD BZ/ANOD	8301 8302 8301
	TJ342	Reveal Clip-In	6.5m	M/F	8301
	TJ345	Fixing Adaptor	5.4m	M/F	8301
	TJ385	Back to Back Adaptor	6.5m	M/F	8301
	TJ307	Flush Pocket Filler Fits with TJ300/301/390/320/333/360/ TJ362/304/344/364/308	6.5m	M/F CL/ANOD BZ/ANOD	8301 8302 8301



# 152.4MM APARTMENT DOOR

**CODE**      **DESCRIPTION**      **LGTH.**    **FINISH**      **GROUP ID**

SD601	Door Head  1721, 1476	6.5m	M/F CL/ANOD	10401 10402	
-------	---	------	----------------	----------------	---

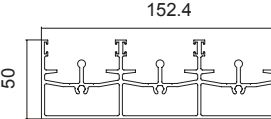
SD605	Closed Sill - Slotted  1721, 1477	6.5m	M/F CL/ANOD	10401 10402	
-------	---	------	----------------	----------------	---





SD603	Universal Threshold  1598	6.5m	M/F CL/ANOD	10401 10402	
-------	---	------	----------------	----------------	---

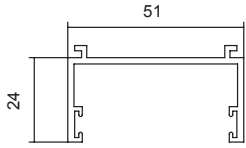
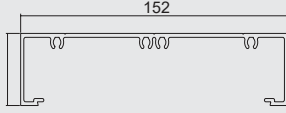

  Key hardware.

 Technical guidance recommended.

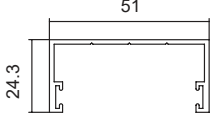
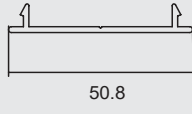
# 152.4MM APARTMENT DOOR

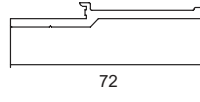





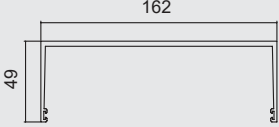

	CODE	DESCRIPTION	LGTH.	FINISH	GROUP ID
	SD600	Jamb Fits with SD468	6.5m	M/F CL/ANOD	10401 10402
	SD468	Slide In Jamb Adaptor Fits with SD400/600/800	6.5m	M/F CL/ANOD	10401 10402
	SD150	150mm Frame  1721	6.5m	M/F CL/ANOD	10401 10402
	SD111	Screw Fix Jamb Adaptor Fits with SD100/150	6.5m	M/F CL/ANOD	10401 10402
	SD128	Head/Sill Track Filler  1721	6.5m	M/F CL/ANOD	10401 10402
	SD469	High Performance Sill Riser Fits with SD402/602	6.5m	M/F CL/ANOD	10401 10402

**TO BE  
DISCONTINUED**

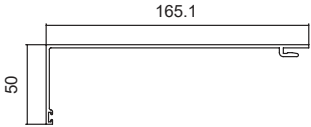

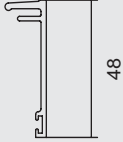

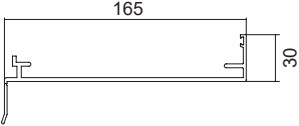

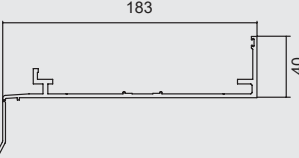
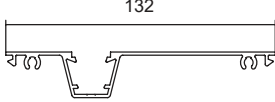
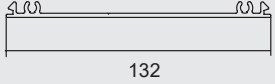
 Key hardware.

# 152.4MM APARTMENT DOOR

CODE	DESCRIPTION	LGTH.	FINISH	GROUP ID	
TJ6157	150mm Sub Head  1710, 1601	6.5m	M/F CL/ANOD	10001 10002	
TJ6158	150mm Sub Head Fits with TJ6159  1601	6.5m	M/F CL/ANOD	10001 10002	
TJ6159	150mm Sub Head Adaptor Fits with TJ6158  1601	6.5m	M/F CL/ANOD	10001 10002	
TJ6156	150mm Sub Sill Slotted  1601	6.5m	M/F CL/ANOD	10001 10002	
TJ679	High Performance 150mm Sub Sill Slotted  1601	6.5m	M/F CL/ANOD	10401 10402	
TJ6164	50mm Offset Adaptor	6.5m	M/F CL/ANOD	8501 8502	
JM2865	132mm Flat Filler	6.5m	M/F CL/ANOD	8701 8702	

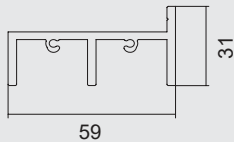
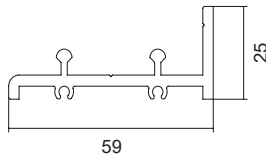
 Key hardware.

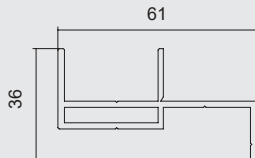
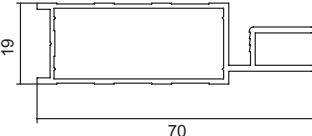

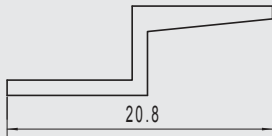
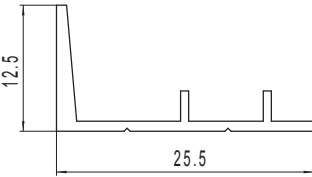
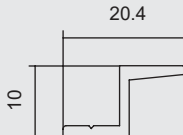



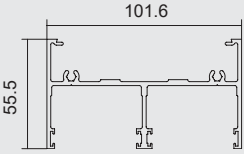

# 152.4MM APARTMENT DOOR

	CODE	DESCRIPTION	LGTH.	FINISH	GROUP ID
	SD621	Double Fly Door Head	6.5m	M/F CL/ANOD	10401 10402
	SD622	Double Fly Door Sill 	6.5m	M/F CL/ANOD	10401 10402
	SD625	Double Fly Door Jamb	6.5m	M/F CL/ANOD	10401 10402
	DF001	7mm Standard Security Door Frame  2650,2651	6.5m	M/F CL/ANOD	2106 2106
	DI3224	7mm Offset Interlock	4.3m	M/F CL/ANOD	2146 2146
	DI3225	Frame Interlock	4.3m	M/F CL/ANOD	2146 2146
	SD626	10mm Interlock	6.5m	M/F CL/ANOD BZ/ANOD	10401 10402 10401

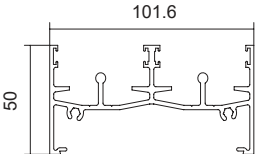
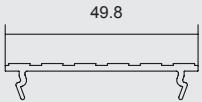
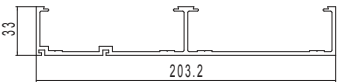
 Key hardware.

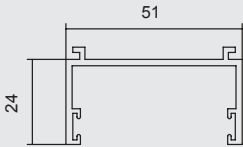
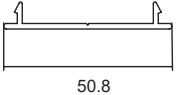
 Technical guidance recommended.

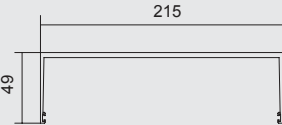
# 203.2MM APARTMENT DOOR

CODE	DESCRIPTION	LGTH.	FINISH	GROUP ID	
SD401	Door Head  1721	6.5m	M/F CL/ANOD	10401 10402	
SD402	Door Sill - Slotted  1721	6.5m	M/F CL/ANOD	10401 10402	
SD603	Threshold	6.5m	M/F CL/ANOD	10401 10402	
SD800	Jamb Fits with SD468/TJ305	6.5m	M/F CL/ANOD	10401 10402	
SD468	Jamb Adaptor Fits with SD400/600/800  1721	6.5m	M/F CL/ANOD	10401 10402	
SD128	Head/Sill Track Filler	6.5m	M/F CL/ANOD	10401 10402	
TJ805	Sub Head  1710, 1601	6.5m	M/F CL/ANOD	10001 10002	
TJ806	Sub Sill  1601, 1685	6.5m	M/F CL/ANOD	10001 10002	

 Key hardware.



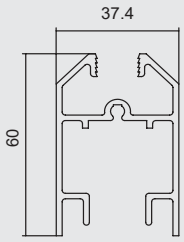
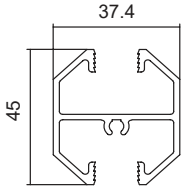
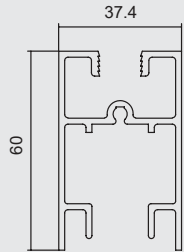
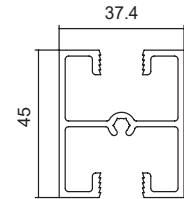
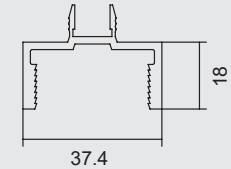



# APARTMENT DOOR SECTIONS

	CODE	DESCRIPTION	LGTH.	FINISH	GROUP ID
	SD104	Raked Top Rail	6.5m	M/F CL/ANOD	10401 10402
	SD110	Raked Mid Rail	6.5m	M/F CL/ANOD	10401 10402
	SD119	Square Rail	6.5m	M/F CL/ANOD	10401 10402
	SD123	Square Mid Rail	6.5m	M/F CL/ANOD	10401 10402
	SD120	DVG Adaptor Fits with SD119	6.5m	M/F CL/ANOD	10401 10402

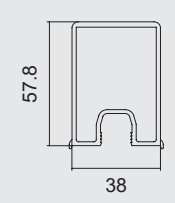
**TO BE  
DISCONTINUED**

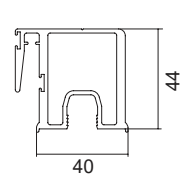

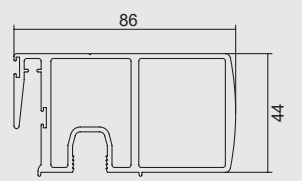
# APARTMENT DOOR SECTIONS

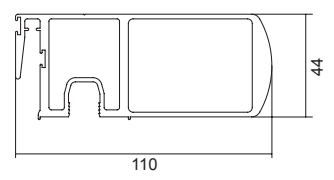
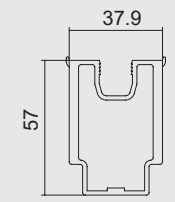









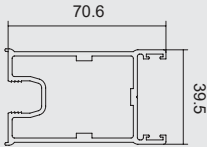

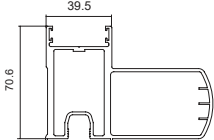
CODE	DESCRIPTION	LGTH.	FINISH	GROUP ID	
SD105	Plain Stile	6.5m	M/F CL/ANOD	10401 10402	
		2.8m	M/F CL/ANOD	10401 10402	
SD106	Interlock Fits with SD137/139  1721, 1672	6.5m	M/F CL/ANOD	10401 10402	
		2.8m	M/F CL/ANOD	10401 10402	
SD137	Box Interlock Fits with SD106/139  1721, 1672	6.5m	M/F CL/ANOD	10401 10402	
		2.8m	M/F CL/ANOD	10401 10402	
SD139	Heavy Duty Box Interlock 150mm Fits with SD106/137  1721, 1672	6.5m	M/F CL/ANOD	10401 10402	
		2.8m	M/F CL/ANOD	10401 10402	
SD141	Male Meeting Stile Fits with SD109/136	6.5m	M/F CL/ANOD	10401 10402	

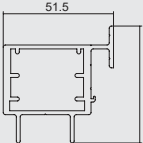
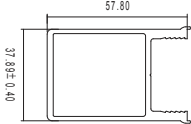
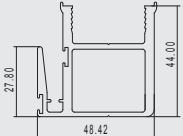

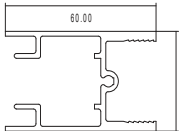
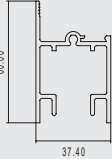
 Key hardware.

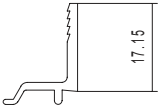

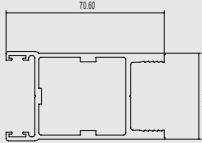

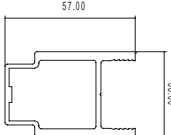





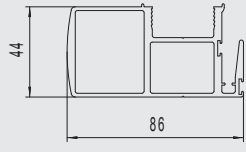

# APARTMENT DOOR SECTIONS

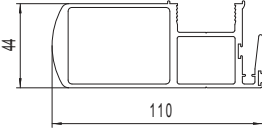
	CODE	DESCRIPTION	LGTH.	FINISH	GROUP ID
	SD109	Female Meeting Stile Fits with SD141  1721	6.5m	M/F CL/ANOD	10401 10402
	SD136	Heavy Duty Female Meeting Stile Fits with SD141  1721	6.5m	M/F CL/ANOD	10401 10402
	SD131	OXO Adaptor Fits with SD106/125/131/137/139/152	6.5m	M/F CL/ANOD	10401 10402
	SD124	Double Glazed Lock Stile	6.5m	M/F CL/ANOD	10401 10402
	SD125	Double Glazed STD Interlock  1721, 1672	6.5m	M/F CL/ANOD	10401 10402
	SD127	Double Glazed Apartment Door Rail	6.5m	M/F CL/ANOD	10401 10402
	SD142	Double Glazed Beaded Rail Fits with SD143 	6.5m	M/F CL/ANOD	10401 10402
	SD143	Double Glazed Rail Bead Fits with SD142 	6.5m	M/F CL/ANOD	10401 10402
	SD145	Double Glazed Female Bipart Fits with SD146  1721	6.5m	M/F CL/ANOD	10401 10402
	SD146	Double Glazed Male Bipart Fits with SD145	6.5m	M/F CL/ANOD	10401 10402

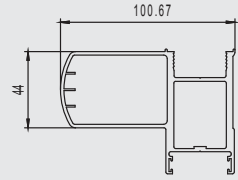
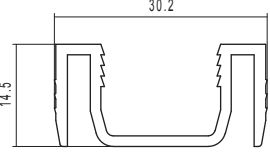
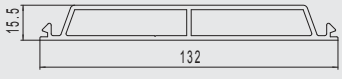
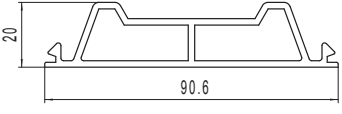
 Key hardware.

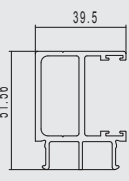
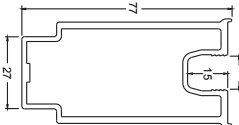
 Please check with your local branch for stock availability.

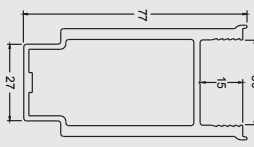



# APARTMENT DOOR SECTIONS

CODE	DESCRIPTION	LGTH.	FINISH	GROUP ID	
SD151	Double Glazed Box Interlock Stile  1672, 1721	6.5m	M/F CL/ANOD	10401 10402	
SD152	Double Glazed Heavy Duty Box Interlock Stile  1672, 1721	6.5m	M/F CL/ANOD	10401 10402	
SD153	Double Glazed Heavy Duty Female Meeting Stile Fits with SD146  1721	6.5m	M/F CL/ANOD	10401 10402	
SD132	12.76mm Glazing Channel and 10.76mm Glazing Adaptor Fits with SD124	6.5m	M/F	10401 10402	
SD627	Apartment Door Sill Brace Suits 150mm track Fits SD602	4m	M/F	10401	
SD628	Apartment Door Sill Brace Suits 101.6mm track	4m	M/F	10401	
SD164	Corner Meeting Stile Female Suits SD109/SD145 Mates with SD161/170  1904 	6.5m	M/F	10401 10402	
SD161	Corner Stile Male SG	6.5m	M/F	10401 10402	 
SD170	Corner Stile Male DG	6.5m	M/F	10401 10402	 

 Key hardware.

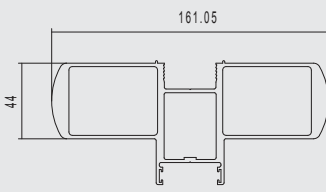
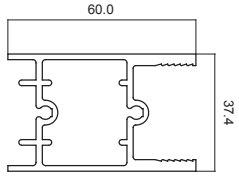
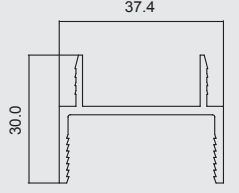
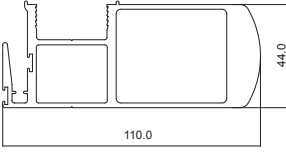
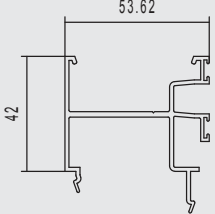
 Technical guidance recommended.

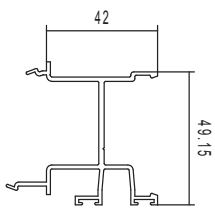
# APARTMENT DOOR SECTIONS - HIGH PERFORMANCE

	CODE	DESCRIPTION	LGTH.	FINISH	GROUP ID
	SD155	Double Box Female	6.5m	M/F	10401
	SD156	Heavy Duty Box Rail	6.5m	M/F	10401
	SD157	33mm Double Glazed Adaptor	6.5m	M/F	10401
	SD158	Extra Heavy Duty Large Box Interlock	6.5m	M/F	10401
	SD159	High Performance External Threshold  1694 	6.5m	M/F	10401
	SD160	High Performance Internal Threshold Suits SD603  1694 	6.5m	M/F	10401

 Key hardware.

 Technical guidance recommended.



\* The high performance door sections are available ex-mill only.

# APARTMENT DOOR HARDWARE

## APARTMENT DOOR HARDWARE

CODE	DESCRIPTION	U.O.M.	BOX QTY.	GROUP ID	
1670	Glazing Channel To Suit 6.38mm Glass - 100m Roll	Roll	N/A	16169	
1604	Glazing Channel To Suit 8.38mm Glass - 100m Roll	Roll	N/A	654	
1671	Glazing Channel To Suit 10.38mm Glass - 100m Roll	Roll	N/A	16169	
1674	Glazing Channel To Suit 24mm Glass - 50m Roll	Roll	N/A	16169	
1669	Glazing Channel To Suit 28mm Glass - 60m Roll	Roll	1	16169	
1685	Sill Flap/Insert - 300m Roll	Roll	N/A	16169	
1686	Sill Flap/Insert PVC - 200m Roll	Roll	N/A	16169	
1672	Interlock Cushion - 100m Roll To Suit SD106	Roll	N/A	16169	
1601	Bulb Seal Co-Extruded	Roll	N/A	16169	
1720	Weatherstrip 69-525 Black - 450m Roll	Roll	5	16173	
1721	Weatherstrip 69-525 Black with Fin - 400m Roll	Roll	5	16173	

## ANTHONY INNOVATIONS **ANTHONY INNOVATIONS APARTMENT DOOR HARDWARE**

CODE	DESCRIPTION	U.O.M.	BOX QTY.	GROUP ID	
1800	Anthony Innovations 9017NA Roller for Single Wheel Sliding Door - 40kg	Each	100	16149	
1801	Anthony Innovations 9017DNA Roller for Dual Wheel Sliding Door - 80kg	Each	100	16149	
1802	Anthony Innovations TraXtar Duo, high performance - 110kg	Each	50	16149	 <b>NEW</b>
1808	Anthony Innovations Quad Roller	Each	20	16149	

# APARTMENT DOOR HARDWARE

	CODE	DESCRIPTION	U.O.M.	BOX QTY.	GROUP ID
	1803	Fixed Panel Adjustment Block	Each	100	16149
	1805	Filler Block to Suit Apartment Door <i>**Specify finish: Black-BL, Gray- GR, White-WH.</i>	Pair 	10	16149
	1806	Anti Lift Block to Suit Apartment Door <i>**Specify finish: Black-BL, Gray- GR, White-WH.</i>	Pair 	10	16149
	1673	90mm PVC Buffer Stop	Each	N/A	16169
	1673-150	150mm Buffer Stop	Each	N/A	16169
	1819	Apartment Door Sill Brace 100mm Fits SD602	Bag	20	16153
	1818	Apartment Door Twin Track Sill Brace 100mm Fits SD402	Bag	20	16153
	1807	End Caps for Apartment Door Threshold (High Performance). Suits SD159/160	Bag	10 Pairs	16109
	1694	End Caps Heavy Duty for Apartment Door Threshold. Suits SD159/160	Bag	10 Pairs	16149
 	1904	Apartment Door Corner Entry Female Stile Block For SD164	Bag	10 Pairs	16149
	2642	Foam Seal - Slide in 500m Roll (Everton)	Roll	N/A	16177
	1678	Rubber Interlock Block Suits SD137/151	Each	N/A	16149
	1679	Rubber Interlock Block Suits SD139/152	Each	N/A	16149
	1478	Foam Seal - 455 Sets Roll. Suits SD401/402	Roll	N/A	16177
	1477	Foam Seal - 995 Pieces Roll. Suits SD602	Roll	N/A	16177
	1476	Foam Seal - 905 Pieces Roll. Suits SD601	Roll	N/A	16177
	1912	Setting Block / Fixed Panel Spacing Block	Bag	500	16157
	1835	Plugs - 10mm Hole	Bag	200	16109
	1058	Door Stopper - Black	Each	N/A	16121
	1598	End Cap Threshold. Suits SD603	Bag	N/A	16109

TO BE DISCONTINUED

 Please check with your local branch for stock availability.

# APARTMENT DOOR HARDWARE











## LOCKWOOD APARTMENT DOOR HARDWARE

CODE	DESCRIPTION	U.O.M.	BOX QTY.	GROUP ID
1252-**	ONYX Lock - D Inner/Slim Outer, 5 Pin Cyl - K/D, Surface Strike <i>**Specify finish: Black-BL, Silver-SCA</i>	Each	10	16149
1352-**	ONYX Lock - D Inner/Slim Outer, 5 Pin Cyl - K/N J031, Surface Strike <i>**Specify finish: Black-BL, Silver-SCA</i>	Each	10	16149
1253	ONYX Lock-D Inner/Slim Outer, 5 Pin Cyl - K/D, Surface Strike Satin Chrome	Each	10	16149
1254-**	ONYX Lock - Slim Inner/Slim Outer, 5 Pin Cyl- K/D, Surface Strike <i>**Specify finish: Black-BL, Silver-SCA</i>	Each	10	16149
1354-**	ONYX Lock - Slim Inner/Slim Outer, 5 Pin Cyl- K/N J031, Surface Strike <i>**Specify finish: Black-BL, Silver-SCA</i>	Each	10	16149
1255	ONYX Lock - Slim Inner/Slim Outer, 5 Pin Cyl- K/D, Surface Strike Satin Chrome	Each	10	16149
1256	ONYX Extra Wide Strike - Black	Each	10	16149
1257	ONYX Extra Wide 25mm Strike - Satin Chrome	Each	10	16149
1260-BL	ONYX Lock Handle Packer - Black	Each	10	16149
1260-SCA	ONYX Lock Handle Packer - Silver	Each	10	16149
1261	ONYX Lock Handle Packer - Satin Chrome	Each	10	16149











# APARTMENT DOOR HARDWARE

	CODE	DESCRIPTION	U.O.M.	BOX QTY.	GROUP ID
	1358-BL	Yarra View Ridge Sliding Glass Door Deadlock - Black	Each	N/A	16149
	1258-**	Yarraview Edge Sliding Door Lock Need 2 Cylinders 1268 or 1269 to go with Lock  <i>**Specify finish: Black-BL, Silver-SCA</i>	Each	5	16149
	1268	C4 5 Pin Cylinder Yarraview - K/Alike - Single Cylinder Only, Key No Is 249	Bag	10	16149
	1269	C4 5 Pin Cylinder Yarraview - K/Differ - Single Cylinder Only	Bag	10	16149
	1269-KAP	C4 5 Pin Cylinder Yarraview- K/Alike In Pairs for Double Cylinders Lock	Bag	5	16149
	1258-SCA-25	25mm Striker Plate	Each	N/A	16149
	1258-BLK-25	25mm Striker Plate	Each	N/A	16149
	1168	Striker Plate - Adjustable	Each	N/A	16149
	1249	Avana Sliding Door lock includes Cylinder DS2150 Black	Each	N/A	16149
	DTL2000	101.6mm Apartment Door Press Suits SD105/106/109/137/139/141	Each	N/A	16149

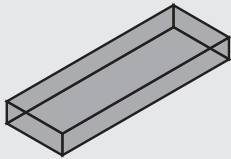

Please check with your local branch for stock availability.

# APARTMENT DOOR HARDWARE

CODE	DESCRIPTION	U.O.M.	BOX QTY.	GROUP ID	
1370**	Dow Corning 688 Silicone Glazing & Cladding Sealant  <i>688**Specify finish: Black-BL, Translucent-Trans, White-WH.</i> 	Tube	24	16161	
1371**	Dow Corning 795 Structural Glazing Silicone  <i>795**Specify finish: Black-BL.</i> 	Sausage	20	16161	
1311**	Dow Corning 680 Sanitary Silicone - Tube (Neutral Cure)  <i>680**Specify finish: Transparent-TR White-WH.</i> 	Tube	20	16161	
1900-M	Frame Packers - 1.5mm X 90mm Blue 100/Bag	Bag	N/A	16157	
1901-M	Frame Packers - 3mm X 90mm Green 100/Bag	Bag	N/A	16157	
1902-M	Frame Packers - 5mm X 90mm Orchre 100/Bag	Bag	N/A	16157	
1903-M	Frame Packers - 10mm X 90mm Black 100/Bag	Bag	N/A	16157	
1910	Setting Blocks 3mm Thick	Bag	N/A	16157	
1911	Setting Blocks 5mm Thick	Bag	N/A	16157	
1912	Setting Blocks 10mm Thick	Bag	N/A	16157	
1977	Setting Blocks 5mm X 25mm - 3m Self Adhesive	Bag	N/A	17320	
1978	Setting Blocks 10mm X 25mm - 3m Self Adhesive	Bag	N/A	17320	
1979	Setting Blocks 3mm X 10mm X 25mm - 3m Double Sided Tape	Bag	N/A	17320	
1930	End Cap to Suit Subsills Bag of 50 Pairs (Left & Right)	Bag	N/A	16157	
1960	Lanotec General Purpose Liquid Lanolin 400g	Tube	12	16181	
1961	Lanotec "Citra Force" Cleaner Degreaser 400g	Tube	12	16181	



Please check with your local branch for stock availability.





## DOOR SECTIONS

### 35MM DOOR

GLASS THICKNESS	CHANNEL RUBBER REQUIRED	POCKET SIZE
6mm	1612	9.6mm

### 45MM SG STANDARD DOOR 45MM SG OPEN POCKET DOOR

GLASS THICKNESS	WEDGE REQUIRED	POCKET SIZE
6mm	1620 - 1620	14.5mm
8mm	1625 - 1625 OR 1620 - 1630	
10mm	1630 - 1630	

### 45MM DG OPEN POCKET DOOR

GLASS THICKNESS	WEDGE REQUIRED	POCKET SIZE
20mm	1933 - 1933	33.2mm
22mm	1615 - 1933	
24mm	1615 - 1615	
26mm	1615 - 1620	
28mm	1620 - 1620	

### STANDARD MULTIFOLD DOOR SYSTEM 45MM FLUSH FACE DOOR (WATER RATED)

GLASS THICKNESS	WEDGE REQUIRED	POCKET SIZE
6mm	1620 - 1620 OR 1620 - 1651 OR 1620 - 1684	14.5mm
8mm	1630 - 1651 OR 1630 - 1684	
10mm	1630 - 1630	
20mm	1933 - 1933	35.1mm
22mm	1615 - 1933	
24mm	1615 - 1615 OR 1933 - 1684	
26mm	1615 - 1620 OR 1615 - 1684	
28mm	1620 - 1620 OR 1620 - 1684	

### 45MM DOUBLE BEADED DOOR - SG 45MM DOUBLE BEADED DOOR - DG

GLASS THICKNESS	SPECIFIC PROFILES REQUIRED	WEDGE REQUIRED	POCKET SIZE
6mm	TJ202 bead	1615 - 1933	16.75mm
12mm		1630 - 1630	
24mm	TJ227 bead	1615 - 1615	35.1mm
26mm		1615 - 1933	
28mm		1620 - 1620	



1612



1615



1620



1625



1630



1933









1651

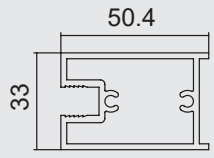

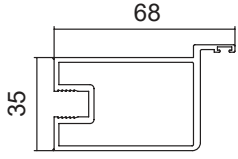
1684

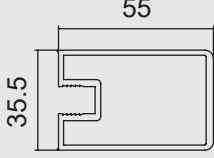
# 35MM DOOR SECTIONS

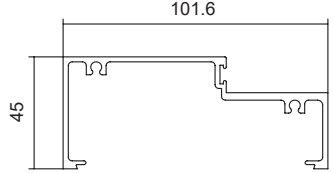







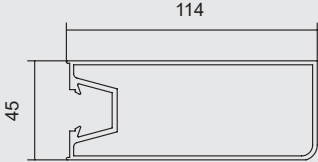

CODE	DESCRIPTION	LGTH.	FINISH	GROUP ID	
TJ380	Top & Bottom Rail Fits with TJ381/382  1612	6.5m	M/F CL/ANOD	9301 9302	
TJ381	Meeting Stile Fits with TJ380/382  1612,1710	6.5m	M/F CL/ANOD	9301 9302	
TJ382	Hinge & Lock Stile Fits with TJ380/381  1612	6.5m	M/F CL/ANOD	9301 9302	
TJ334	35mm Door Threshold Fits with TJ301/300/390/380/381/382  1720	6.5m	M/F CL/ANOD	9301 9302	

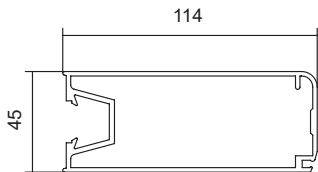

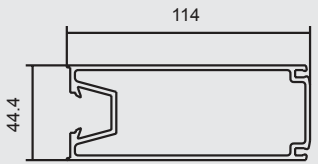
  Key hardware.

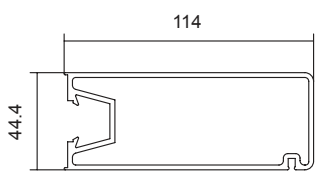
# 45MM DOOR SECTIONS

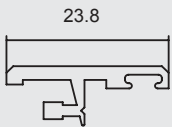
## STANDARD

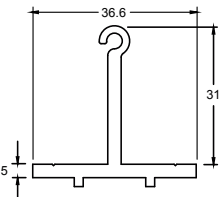







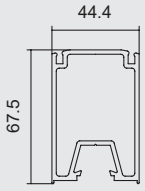

	CODE	DESCRIPTION	LGTH.	FINISH	GROUP ID
	TJ154	114mm Hinge Stile Fits with TJ313/315  1816	6.5m	M/F CL/ANOD	9401 9402
	TJ155	114mm Lock Stile Fits with TJ313/315  1816, 2590, 2600, 2610, 2620	6.5m	M/F CL/ANOD	9401 9402
	TJ158	114mm Pivot Stile Fits with TJ313/315  1816, 2590, 2600, 2610, 2620	6.5m	M/F CL/ANOD	9401 9402
	TJ159	114mm Sliding Stile Fits with TJ313/315  1816, 2590, 2600, 2610, 2620	6.5m	M/F CL/ANOD	9401 9402
	TJ332	Door Cover Fits with TJ312/321/155/158/412/ TJ440/450/HV312  1710	6.5m	M/F CL/ANOD	9701 9402
	TJ212	Mid Rail Bracket	4m	M/F	9401

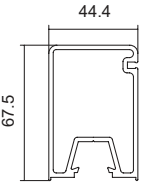

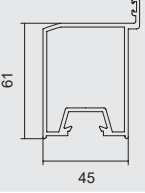
 Key hardware.

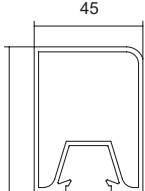
# 45MM DOOR SECTIONS

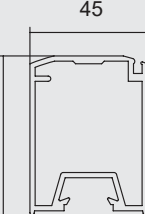

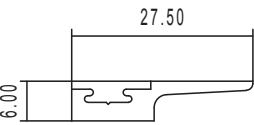
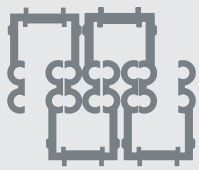
## STANDARD

CODE	DESCRIPTION	LGTH.	FINISH	GROUP ID	
TJ321	Pivot Door Stile Fits with TJ313/315  1816, 2590, 2600, 2610, 2620	6.5m	M/F CL/ANOD BZ/ANOD	9401 9402 9401	
TJ322	Sliding Door Stile Fits with TJ313/315  1816, 2590, 2600, 2610, 2620	6.5m	M/F CL/ANOD BZ/ANOD	9401 9402 9401	
TJ327	Meeting Stile Fits with TJ313/315  1816, 1705, 1710, 1714, 1715	6.5m	M/F CL/ANOD BZ/ANOD	9401 9402 9401	
TJ311	Hinge Stile Fits with TJ313/315  1816	6.5m 2.8m	M/F CL/ANOD BZ/ANOD M/F CL/ANOD	9401 9402 9401 9402	
TJ312	Lock Stile Fits with TJ313/315  1816, 2590, 2600, 2610, 2620	6.5m 2.8m	M/F CL/ANOD BZ/ANOD M/F CL/ANOD	9401 9402 9401 9402	
TJ341	Plant on Interlock  1720, 1721	6.5m	M/F CL/ANOD	9400 9400	
1816	Spigots for Commercial Doors Set of 4 with Bolts	Set	M/F	16169	

  Key hardware.



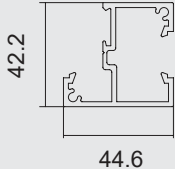
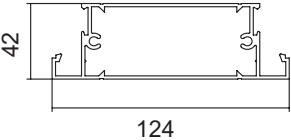
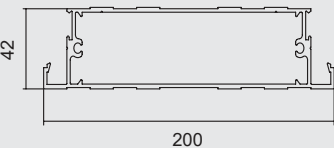
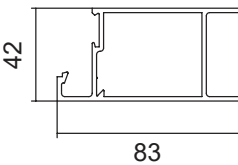

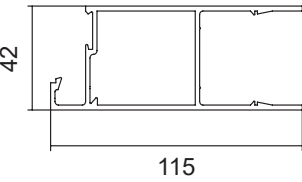
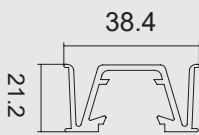

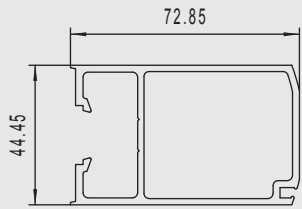

# 45MM DOOR SECTIONS

## STANDARD

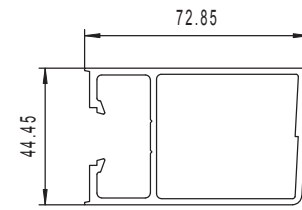
	CODE	DESCRIPTION	LGTH.	FINISH	GROUP ID
	TJ326	45mm Mid Rail Fits with TJ311/312/314/321/322/327/ TJ154/155/158/159	6.5m	M/F CL/ANOD BZ/ANOD	9401 9402 9401
	TJ124	124mm Mid Rail Fits with TJ311/312/314/321/322/327/ TJ154/155/158/159	6.5m	M/F CL/ANOD BZ/ANOD	9401 9402 9401
	TJ369	200mm Mid Rail Fits with TJ311/312/314/321/322/327/ TJ154/155/158/159	6.5m	M/F CL/ANOD	9401 9402
	TJ313	Door Top Rail Fits with TJ311/312/314/321/322/327/ TJ154/155/158/159	6.5m	M/F CL/ANOD BZ/ANOD	9401 9402 9401
	TJ314	Door Bead Fits with TJ124/313/315/326/369	6.5m	M/F CL/ANOD BZ/ANOD	9401 9402 9401
	TJ315	Door Bottom Rail Fits with TJ311/312/314/321/322/327/ TJ154/155/158/159	6.5m	M/F CL/ANOD BZ/ANOD	9401 9402 9401
	TJ316	Mid Rail Adaptor Fits with TJ315	6.5m	M/F CL/ANOD	9401 9402

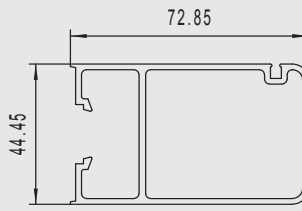
# 45MM DOOR SECTIONS

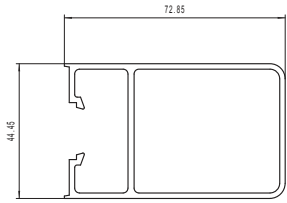

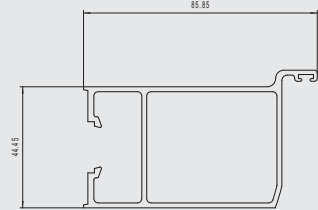
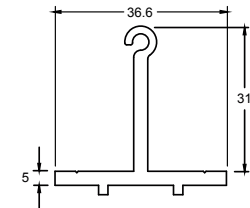





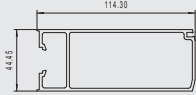

## OPEN POCKET

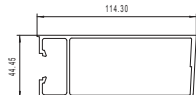
CODE	DESCRIPTION	LGTH.	FINISH	GROUP ID	
TJ440	73mm Open Pocket Lock Stile Fits with TJ313/315/332  2590, 2600, 2610, 2620, 1817	6.5m	M/F CL/ANOD	9401 9402	
TJ441	73mm Open Pocket Hinge Stile Fits with TJ313/315  1817	6.5m	M/F CL/ANOD	9401 9402	
TJ442	73mm Open Pocket Sliding Stile Fits with TJ313/315  2590, 2600, 2610, 2620, 1817	6.5m	M/F CL/ANOD	9401 9402	
TJ443	73mm Open Pocket Plain Stile Fits with TJ313/315/332  1817	6.5m	M/F CL/ANOD	9401 9402	
TJ444	73mm Open Pocket Meeting Stile Fits with TJ313/315  1710, 1817	6.5m	M/F CL/ANOD	9401 9402	
TJ212	Mid Rail Bracket	4m	M/F	9401	

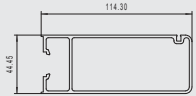
 Key hardware.

# 45MM DOOR SECTIONS

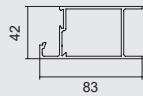

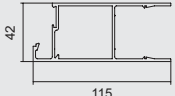
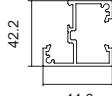
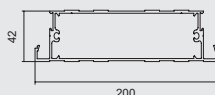
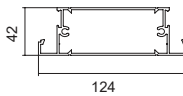
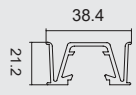
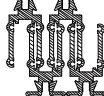







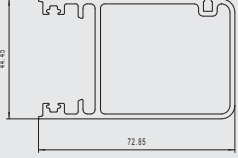

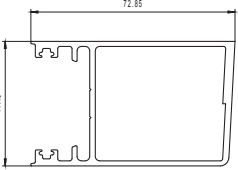
## OPEN POCKET

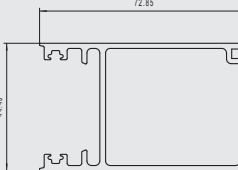
	CODE	DESCRIPTION	LGTH.	FINISH	GROUP ID
	TJ450	114mm Open Pocket Lock Stile Fits with TJ313/315/332  2590, 2600, 2610, 2620, 1817	6.5m	M/F CL/ANOD	9401 9402
	TJ451	114mm Open Pocket Hinge Stile Fits with TJ313/315  1817	6.5m	M/F CL/ANOD	9401 9402
	TJ452	114mm Open Pocket Sliding Stile Fits with TJ313/315  2590, 2600, 2610, 2620, 1817	6.5m	M/F CL/ANOD	9401 9402
	TJ453	114mm Open Pocket Plain Stile Fits with TJ313/315  1817	6.5m	M/F CL/ANOD	9401 9402
	TJ313	Door Top Rail Fits with TJ440/441/442/443/444/450/ TJ451/452	6.5m	M/F CL/ANOD	9401 9402
	TJ314	Door Bead Fits with TJ313/315	6.5m	M/F CL/ANOD	9401 9402
	TJ315	Door Bottom Rail Fits with TJ440/441/442/443/444/450/ TJ451/452	6.5m	M/F CL/ANOD	9401 9402
	TJ326	45mm Mid Rail Fits with TJ311/312/314/321/322/327/ TJ154/155/158/159	6.5m	M/F CL/ANOD BZ/ANOD	9401 9402 9401
	TJ369	200mm Mid Rail Fits with TJ311/312/314/321/322/327/ TJ154/155/158/159	6.5m	M/F CL/ANOD	9401 9402
	TJ124	124mm Mid Rail Fits with TJ311/312/314/321/322/327/ TJ154/155/158/159	6.5m	M/F CL/ANOD BZ/ANOD	9401 9402 9401
	TJ316	Mid Rail Adaptor Fits with TJ315	6.5m	M/F CL/ANOD	9401 9402
	1817	Open Pocket Spigot (Single Glazed & Double Glazed) Set of 4 with Bolts	N/A	Sets	16169

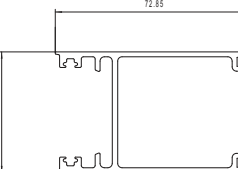
 Key hardware.

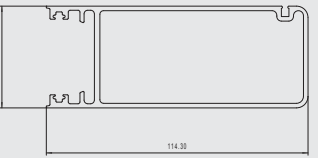
# 45MM DOOR SECTIONS

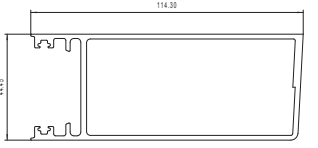
## OPEN POCKET - DOUBLE GLAZED

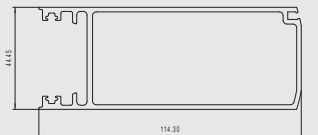
CODE	DESCRIPTION	LGTH.	FINISH	GROUP ID	
TJ416	73mm Open Pocket Sliding Stile Fits with TJ419/420  1817, 2590, 2600, 2610, 2620	6.5m	M/F CL/ANOD	9401 9402	
TJ417	73mm Open Pocket Hinge Stile Fits with TJ419/420  1817	6.5m	M/F CL/ANOD	9401 9402	
TJ418	73mm Open Pocket Sliding Stile Fits with TJ419/420  2590, 2600, 2610, 2620, 1817	6.5m	M/F CL/ANOD	9401 9402	
TJ421	73mm Open Pocket Pivot Stile Fits with TJ419/420  2590, 2600, 2610, 2620, 1817	6.5m	M/F CL/ANOD	9401 9402	
TJ428	114mm Open Pocket Sliding Stile Fits with TJ419/42  1817, 2590, 2600, 2610, 2620	6.5m	M/F CL/ANOD	9401 9402	
TJ435	114mm Open Pocket Hinge Stile Fits with TJ419/420  1817	6.5m	M/F CL/ANOD	9401 9402	
TJ436	114mm Open Pocket Lock Stile Fits with TJ419/420  1817, 2590, 2600, 2610, 2620	6.5m	M/F CL/ANOD	9401 9402	

 Key hardware.



# 45MM DOOR SECTIONS











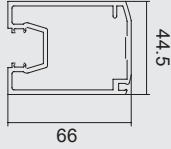

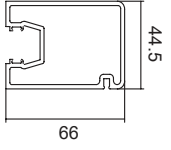
## OPEN POCKET - DOUBLE GLAZED

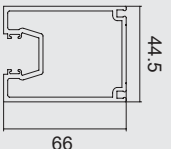
	CODE	DESCRIPTION	LGTH.	FINISH	GROUP ID
	TJ437	114mm Open Pocket Plain Stile Fits with TJ419/420/438  1817	6.5m	M/F CL/ANOD	9401 9402
 	TJ439	114mm Open Pocket Pivot Stile Fits with TJ419/420	6.5m	M/F CL/ANOD	9401 9402
	TJ419	Double Glazed Top Rail Fits with TJ227	6.5m	M/F CL/ANOD	9401 9402
	TJ420	Double Glazed Bottom Rail Fits with TJ227	6.5m	M/F CL/ANOD	9401 9402
	TJ227	Double Glazed Bead Fits with TJ419/420/438	6.5m	M/F CL/ANOD	9401 9402
	TJ438	Double Glazed 100mm MidRail Fits with TJ227	6.5m	M/F CL/ANOD	9401 9402
 	TJ212	Mid Rail Bracket	4m	M/F	9401
	1817	Open Pocket Spigot (Single Glazed & Double Glazed) Set of 4 with Bolts	N/A	Sets	16169

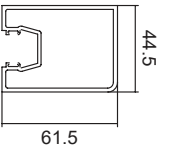
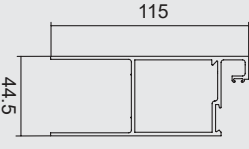
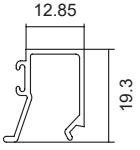
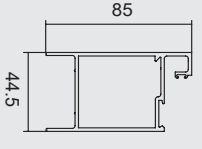
 Key hardware.

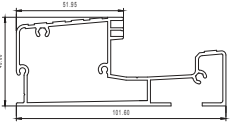
# 45MM DOOR SECTIONS

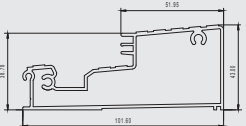

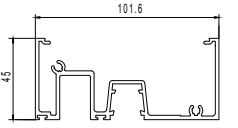

## FLUSH FACE

CODE	DESCRIPTION	LGTH.	FINISH	GROUP ID	
HV312	Lock Stile  1825, 2590, 2600, 2610, 2620	6.5m	M/F CL/ANOD	10501 10502	
HV322	Sliding Door Stile  1825, 2590, 2600, 2610, 2620	6.5m	M/F CL/ANOD	10501 10502	
HV271	Door Stile  1682, 1825, 2590, 2600, 2610, 2620	6.5m	M/F CL/ANOD	10501 10502	
		2.8m	M/F CL/ANOD	10501 10502	
HV272	Hinge Stile  1825	6.5m	M/F CL/ANOD BZ/ANOD	10501 10502 10501	
HV273	Large Rail Fits with HV274	6.5m	M/F CL/ANOD	10501 10502	
HV274	Door Bead Fits with HV273/289	6.5m	M/F CL/ANOD	10501 10502	
HV289	Small Rail Fits with HV274	6.5m	M/F CL/ANOD	10501 10502	
TJ348	Water-rated Sill Inward  1926	6.5m	M/F CL/ANOD	8301 8302	 
TJ349	Water-rated Sill Outward  1926	6.5m	M/F CL/ANOD	8301 8302	 
TJ346	Water-rated Head (Inward & Outward) Fits with HV031  1754	6.5m	M/F	17310	

 Key hardware.

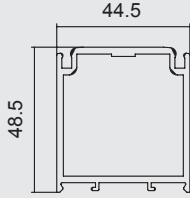
# 45MM DOOR SECTIONS

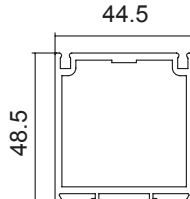
## DOUBLE BEADED DOOR

	CODE	DESCRIPTION	LGTH.	FINISH	GROUP ID
	TJ200	Pivot Stile Fits with TJ202/227  1820, 2590, 2600, 2610, 2620	6.5m	M/F CL/ANOD	9501 9502
	TJ201	Hinge Stile/Plain Fits with TJ202/227  1820	6.5m	M/F CL/ANOD	9501 9502
	TJ204	Sliding Stile Fits with TJ202/227  1820, 2590, 2600, 2610, 2620	6.5m	M/F CL/ANOD	9501 9502
	TJ211	Multifold Door Stile Fits with TJ202/227  1682, 2590, 2600, 2610, 2620	6.5m	M/F CL/ANOD	9501 9502
	TJ220	Multifold Door Stile Fits with TJ202/227  1820, 2590, 2600, 2610, 2620	6.5m	M/F CL/ANOD	9501 9502
	TJ202	Door Bead Fits with TJ200/201/204/210/211/226	6.5m	M/F CL/ANOD	9501 9502

 Key hardware.

# 45MM DOOR SECTIONS

## DOUBLE BEADED DOOR

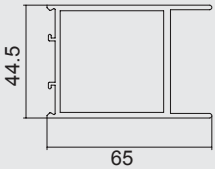
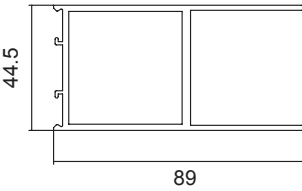
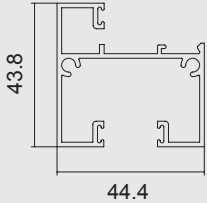
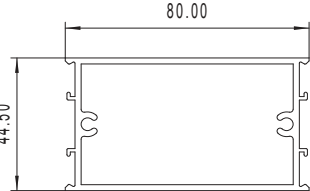
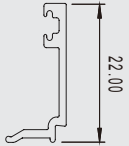
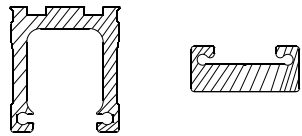
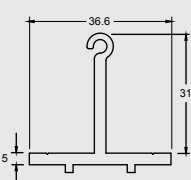
CODE	DESCRIPTION	LGTH.	FINISH	GROUP ID	
TJ207	Top Rail Fits with TJ202/227	6.5m	M/F CL/ANOD	9501 9502	
TJ203	Bottom Rail Fits with TJ202/227	6.5m	M/F CL/ANOD	9501 9502	
TJ226	45mm Mid Rail Fits with TJ202	6.5m	M/F CL/ANOD	9501 9502	
TJ209	80mm Mid Rail Fits with TJ202/227	6.5m	M/F CL/ANOD	9501 9502	
TJ227	Double Glazed Bead Fits with TJ200/201/203/204/207/208/ TJ209/211/220	6.5m	M/F CL/ANOD	9501 9502	
1820	Spigots For TJ200 Stiles Set of 4 with Bolts	Set	N/A	16153	
TJ212	Mid Rail Bracket	4m	M/F	9401	



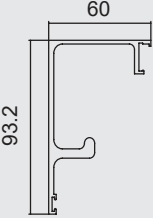
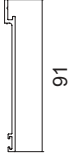
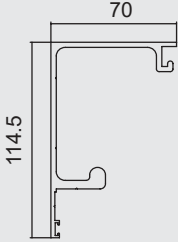
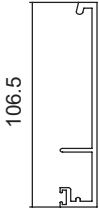
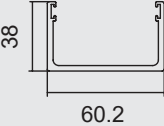



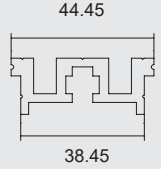

# COMMERCIAL DOOR TRACKS

	CODE	DESCRIPTION	LGTH.	FINISH	GROUP ID
	TJ323	Top Hung Door Track Fits with TJ324 Uses Roller 1810 🔑 1810, 1720	6.5m	M/F CL/ANOD BZ/ANOD	9601 9602 9601
	TJ324	Top Hung Door Track Cover Fits with TJ323 🔑 1720	6.5m	M/F CL/ANOD BZ/ANOD	9601 9602 9601
	TJ365	Heavy Duty Top Hung Door Track Fits with TJ366 Uses Roller 1809 🔑 1809, 1720	6.5m	M/F CL/ANOD	9601 9602
	TJ366	Heavy Duty Top Hung Door Track Cover Fits with TJ365 🔑 1720	6.5m	M/F CL/ANOD	9601 9602
	TJ325	Door Guide / Receiver Fits with TJ323/365 🔑 1720	6.5m	M/F CL/ANOD BZ/ANOD	9601 9602 9601

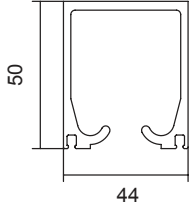

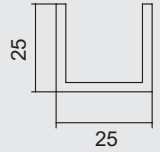
 Key hardware.

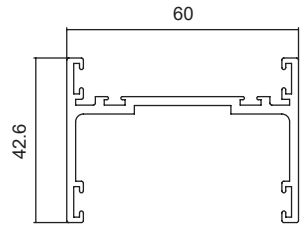
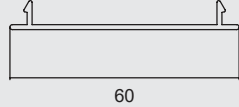

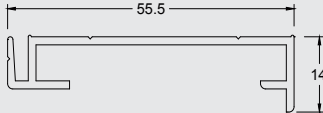



# COMMERCIAL DOOR TRACKS

CODE	DESCRIPTION	LGTH.	FINISH	GROUP ID	
TJ361	Stacking Door Track  1811	6.5m	M/F CL/ANOD	9601 9602	
TJ343	Top Hung Stacking Door Track  1813, 1814, 1815, 2590	6.5m	M/F CL/ANOD	9601 9602	
CH3218	Channel 25 x 25 x 3mm  1815	6.5m	M/F CL/ANOD	10301 10302	
TJ328	Door Guide / Receiver  1720	6.5m	M/F CL/ANOD	10301 10302	
TJ329	Door Guide / Cover Fits with TJ328	6.5m	M/F CL/ANOD	9401 9402	
TJ374	Pip Track	6.5m	M/F CL/ANOD	9401 9402	
LV052	50MM Louvre Blade Suits Commercial Door Suits LV050	6.5m	M/F CL/ANOD	22801	



 Key hardware.

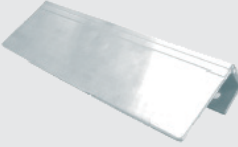



# DOOR SECTION HARDWARE

	CODE	DESCRIPTION	U.O.M.	BOX QTY.	GROUP ID
	1001	Entrance Handle 300 x 32 Back to Back Straight SSS	Set	12	16113
	1002	Entrance Handle 300 x 32 Back to Back Offset SSS	Set	12	16113
	1003	Entrance Handle 300 x 32 Back to Back Curved SSS	Set	12	16113
	1004	Entrance Handle 178 x 19 Offset SSS	Each	50	16113
	1020**	Entrance Handle Elephant Ears 230mm Includes Bolts <i>**Specify finish: Black - BL, Bronze Anod - BA, Clear Anod - CA, Mill Finish - MF, Primrose - PR, White - WH.</i>	Pair	1	16113
	1056	Panic Bolt Visible Fix OffSet 300mm	Each	10	16121
	1057	Panic Bolt Visible Fix 300mm	Each	10	16121
	1059	Floor Mounted Door Stop - Satin Chrome	Each	50	16121

 Key hardware.

 Please check with your local branch for stock availability.

# HINGES

CODE	DESCRIPTION	U.O.M.	BOX QTY.	GROUP ID	
1030**	Hinge Wrap Around Type <i>**Specify finish: Black-BL, Clear Anod-CA.</i>	Each	6	16117	
1035	Heavy Duty Fast Fix Hinge	Each	N/A	16117	 <b>NEW</b>
1040	Hinge Fast Fix Stainless Steel ST3 For Aluminium to Aluminium	Each	100	16117	
1041	Hinge Fast Fix Stainless Steel ST9 For Timber Door to Aluminium	Each	100	16117	
1045	Hinge Fast Fix Aluminium ST3 CL/Anod Aluminium to Aluminium	Each	20	16117	

## Brio *BRIO HINGES RANGE*

CODE	DESCRIPTION	U.O.M.	BOX QTY.	GROUP ID	
1047 - SS	Adjustable Hinge Set 100 Non-Morticed - S/Steel	Set	N/A	16101	 <b>NEW</b>
1047 - BL	Adjustable Hinge Set 100 Non-Morticed - Black (PVD)	Set	N/A	16101	
1046 - BL	Adjustable Hinge Set 50 Non-Morticed - Black (powdercoat)	Set	N/A	16101	 <b>NEW</b>
1046 - WH	Adjustable Hinge Set 50 Non-Morticed - White (powdercoat)	Set	N/A	16101	
1046 - SN	Adjustable Hinge Set 50 Non-Morticed - Satin Nickel	Set	N/A	16101	

 Please check with your local branch for stock availability.



# DOOR SECTION HARDWARE

## YALE FIXED POWER DOOR CLOSER RANGE

	CODE	DESCRIPTION	U.O.M.	BOX QTY.	GROUP ID
	1069-3	Yale Size 3 Standard Arm Door Closer (60Kg Max) Silver - Door Pulls Open From Inside	Each	1	16125
	1069-4	Yale Size 4 Standard Arm Door Closer (80Kg Max) Silver - Door Pulls Open From Inside	Each	1	16125
	1069-5	Yale Size 5 Standard Arm Door Closer (100Kg Max) Silver - Door Pulls Open From Inside	Each	1	16125
	1070-3	Yale Size 2 Parallel Arm Door Closer (40Kg Max) Silver - Door Pushes Open From Inside	Each	1	16125
	1070-4	Yale Size 3 Parallel Arm Door Closer (60Kg Max) Silver - Door Pushes Open From Inside	Each	1	16125
	1070-5	Yale Size 4 Parallel Arm Door Closer (80Kg Max) Silver - Door Pushes Open From Inside	Each	1	16125
	1071-03	Yale Hold Open Arm Suits 1069-3 & 1071-01 Closers	Each	1	16125

## YALE POWER ADJUSTABLE DOOR CLOSER

	1071-01	Yale Power Adjustable Door Closer Size Range 2-6	Each	1	16125
	1071-02	Yale Slide Arm Assembly Suits 1071-01	Each	1	16125
	1071-03	Yale Hold Open Arm Suits 1069- & 1071-01 Closers	Each	1	16125

*Build-in Delayed Action and Back Check.  
Each Pack Contains "Z" Parallel Bracket.*

# DOOR CLOSERS



## LOCKWOOD OVERHEAD TRANSOM RANGE - FITS WITH TJ350 & TJ351

CODE	DESCRIPTION	U.O.M.	BOX QTY.	GROUP ID
1074-3	Lookwood Size 3, Non-Hold, Open Transom Closer	Each	1	16125
1074-4	Lookwood Size 4, Non-Hold, Open Transom Closer	Each	1	16125
1077-3	Lookwood Size 3, 90 Degree Hold, Open Transom Closer	Each	1	16125
1077-4	Lookwood Size 4, 90 Degree Hold, Open Transom Closer	Each	1	16125
1078-3	Lookwood Size 3, 105 Degree Hold, Open Transom Closer	Each	1	16125
1078-4	Lookwood Size 4, 105 Degree Hold, Open Transom Closer	Each	1	16125



\*\* Other Sizes Available On Request



## LOCKWOOD POWER ADJUSTABLE SURFACE MOUNTED

CODE	DESCRIPTION	U.O.M.	BOX QTY.	GROUP ID
1060 2024 SIL	Lockwood 2000 Series Door Closer, Silver - Standard Arm (Power adj sizes 2, 3 and 4) - Parallel Arm (Power adj sizes 2 and 3)	Each	8	16125
1061 2024 COPSIL	Lockwood 2000 Series Door Closer, Silver. - Standard Arm (Power adj sizes 2, 3 and 4) - Parallel Arm (Power adj sizes 2 and 3) - Back Check Included	Each	8	16125



## RYOBI. RYOBI PARALLEL ARM + HOLD OPEN ARM CLOSER

CODE	DESCRIPTION	U.O.M.	BOX QTY.	GROUP ID
1085 3-200- 637	Ryobi 163P Door Closer - Parallel + Hold Open Arms (60Kgs Max.)	Each	1	16125



## dormakaba DORMAKABA DOOR CLOSER

CODE	DESCRIPTION	U.O.M.	BOX QTY.	GROUP ID
1072-1	Dormakaba TS77 Standard Arm, Size 2 (40kg) Closer, Silver	Each	1	16125
1072-2	Dormakaba TS77 Standard Arm, Size 3 (60kg) Closer, Silver	Each	1	16125
1072-3	Dormakaba TS77 Standard Arm, Size 4 (80kg) Closer, Silver	Each	1	16125



# LOCKS - COMMERCIAL



## LOCKWOOD SHORT BACK SET, CYLINDERS & ACCESSORIES

	CODE	DESCRIPTION	U.O.M.	BOX QTY.	GROUP ID
 <p>Cylinder or Escutcheon Not Included</p>	1150	Lockwood 3540F Series Single Action Cylinder & Lever - 22mm Throw Bolt (No Cylinder or Escutcheon Included)	Each	10	16129
	1151	Lockwood 3541F Series Single Action Cylinder & Lever - 28mm Hook Throw Bolt (No Cylinder or Escutcheon Included)	Each	10	16129
	1152	Lockwood 3542F Series Single Action Cylinder & Lever - 35mm Hook Throw Bolt - No Strike Box (No Cylinder or Escutcheon Included)	Each	10	16129
	1150-ESC	Lockwood 3540F Mortice Lock Escutcheon & Retaining Clip	Each	10	16129
	1126	Cylinder To Suit 3540 - Key To Differ	Each	10	16133
	1127	Cylinder To Suit 3540 - Key Alike	Each	10	16133









## YALE SHORT BACK SET, CYLINDERS & ACCESSORIES

	CODE	DESCRIPTION	U.O.M.	BOX QTY.	GROUP ID
	1180	Short Backset Mortice Lock - 22mm Throw - Cylinder & Turn	Each	20	16129
	1181	Short Backset Mortice Lock - 22mm Throw - Double Cylinder	Each	20	16129
	1182	Short Backset Mortice Lock - 36mm Throw - Cylinder & Turn	Each	20	16129
	1183	Short Backset Mortice Lock - 36mm Throw - Double Cylinder	Each	20	16129
	1184	Sliding Door Short Backset Mortice Lock - 29mm Hook Throw - Cylinder & Turn With Strike Box	Each	20	16129
	1185	Sliding Door Short Backset Mortice Lock - 29mm Hook Throw - Double Cylinder With Strike Box	Each	20	16129
	1188	Escape Lever	Each	N/A	16129



## DORMAKABA SHORT BACK SET, CYLINDERS & ACCESSORIES

	CODE	DESCRIPTION	U.O.M.	BOX QTY.	GROUP ID
 	1197	Dormakaba 950 lock body 22mm bolt, incl. 2 Escutheons, C4 Cyl. and C/F Turn	Each	N/A	16129
 	1198	Dormakaba 950 Lock Body 37mm bolt, incl. 2 Escutheons, C4 Cyl. and C/F Turn	Each	N/A	16129
 	1199	Dormakaba 951 Lock Body 29mm hook bolt, incl. 2 Escutheons, C4 Cyl. and C/F Turn	Each	N/A	16129

# LOCKS - COMMERCIAL







## LOCKWOOD SELECTOR MORTICE LOCKS & KITS, CYLINDERS

CODE	DESCRIPTION	U.O.M.	BOX QTY.	GROUP ID	
1109	Extended Bi-Fold Striker	Each	N/A	16129	 
1175	Lockwood Selector 3782SS Short Backset Mortice Lock <i>No Cylinder Included</i>	Each	10	16129	
1103-ADP	Snib Adaptor Suit 1103 Furniture	Each	10	16133	
1176	Lockwood Selector 3782 Lock Kit 01 Double Cylinder Set - Includes: <ul style="list-style-type: none"> <li>• 3782SS Mortice Lock</li> <li>• 4801/70SC Lever on External Plate with Cylinder Hole</li> <li>• 4901/70SC Lever on Internal Plate with Cylinder Hole</li> <li>• Double Cylinder</li> <li>• Accessory Packets To Suit</li> </ul>	Set	10	16129	 <p>4801/70    4901/70</p>
1177	Lockwood Selector 3782 Lock Kit 04 Cylinder And Turn Set -Includes: <ul style="list-style-type: none"> <li>• 3782SS Mortice Lock</li> <li>• 4801/70SC Lever on External Plate with Cylinder Hole</li> <li>• 4904/70SC Lever on Internal Plate with Turnknob</li> <li>• Cylinder</li> <li>• Turnknob Adaptor</li> <li>• Accessory Packets To Suit</li> </ul>	Set	10	16129	 <p>4801/70    4904/70</p>
1178	Lockwood Selector 3782 Lock Kit 05 Single Cylinder Set - Includes: <ul style="list-style-type: none"> <li>• 3782SS Mortice Lock</li> <li>• 4801/70SC Lever on External Plate with Cylinder Hole</li> <li>• 4905/70SC Lever on Internal Plain Plate</li> <li>• Cylinder</li> <li>• Accessory Packets To Suit</li> </ul>	Set	10	16129	 <p>4801/70    4904/70</p>

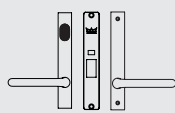
# LOCKS - COMMERCIAL

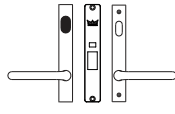

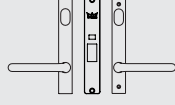

## dormakaba DORMAKABA SELECTOR MORTICE LOCKS & KITS, CYLINDERS

		CODE	DESCRIPTION	U.O.M.	BOX QTY.	GROUP ID
		1193	Dormakaba ST9212 Classroom Lock Kit, External Cylinder with 6400/6406/30	Each	N/A	16129
		1192	Dormakaba ST9212 Office Lock Kit, Cylinder and Turn with 6400/6403/30	Each	N/A	16129
		1191	Dormakaba ST9212 Lock Kit, Double Cylinder Entry Lock with 6400/6401/30	Each	N/A	16129

## ALLEGION ALLEGION VERTA RANGE

		CODE	DESCRIPTION	U.O.M.	BOX QTY.	GROUP ID
		1011	Verta Furniture Plate	Each	N/A	16129
		1012	Verta Offset Pull Handle	Each	N/A	16129
		1013	Verta 800mm Inline Pull Handle	Each	N/A	16129
		1014	Verta Euro Cylinder Escutcheon	Each	N/A	16129
		1113	Sliding Mortice Lock 28.5mm Backset	Each	N/A	16129
		1015	Verta Flush Pull	Each	N/A	16129







## ACCESSORIES

		CODE	DESCRIPTION	U.O.M.	BOX QTY.	GROUP ID
		1699	6mm 304 SS Rod, 6 metre	Set	N/A	16101
		1699-Grub	Grub Screw 1/4" X 1/2" UNC CUP PNT	Set	N/A	16101

# LOCKS - COMMERCIAL



## PLATE FURNITURE FOR LOCKWOOD SELECTOR / SYNERGY LOCKS

CODE	DESCRIPTION	U.O.M.	BOX QTY.	GROUP ID	
1101	Lockwood 4905/70 Internal Plate & Lever No Cylinder Hole - SCP	Each	10	16129	
1102	Lockwood 4901/70 Internal Plate & Lever With Cylinder Hole - SCP	Each	10	16129	
1103	Lockwood 4904/70 Internal Plate & Lever With Turn - SCP	Each	10	16129	
1104	Lockwood 4800 External Plate With Cylinder Hole - SCP	Each	10	16129	
1105	Lockwood 4801/70 External Plate & Lever With Cylinder Hole - SCP	Each	10	16129	
1122	Cylinder Single To Suit 3582 W - Cam** - Key to Differ	Each	20	16133	
1123	Cylinder Single To Suit 3582 W - Cam** - Key Alike  **Cylinder & Turn Function Outside 1105 / 1103 Inside	Each	20	16133	
1124	Cylinder Single To Suit 3582 X - Cam** - Key to Differ	Each	20	16133	
1125	Cylinder Single To Suit 3582 X - Cam** - Key Alike  **Cylinder & Turn Function Outside 1105 / 1103 Inside	Each	20	16133	





# LOCKS - COMMERCIAL



## PLATE FURNITURE FOR LOCKWOOD SELECTOR / SYNERGY LOCKS

	CODE	DESCRIPTION	U.O.M.	BOX QTY.	GROUP ID
	1141	Optimum 2 Point Lock Body Only - 30mm Backset - No Cylinder	Each	10	16129
	1147	Palladium Handle - Black Suits 1141 Lock	Set	10	16129
	1148	Palladium Handle - Satin Pearl Suits 1141 Lock	Set	10	16129
	1142	Palladium "Xtra" Handle Entrance Set - Black. To Fit with 1141	Each	10	16129
	1143	Palladium "Xtra" Handle Entrance Set - Satin Chrome. To Fit with 1141	Each	10	16129
	1153	Optimum / Palladium Kits - Black (1141 Lock & Striker, 1147) - No Cylinder	Set	10	16129
	1154	Optimum / Palladium Kits - Satin Chrome (1141 Lock & Striker, 1148) - No Cylinder	Set	10	16129
	1155	Sorrento Face Mount Single Point Lock - No Cylinder	Each	N/A	16129
	1157	Lazy Cam Cylinder	Each	10	16129
	1159	Flush Tabs	Pair	N/A	16129
	1144	Euro Cylinder - 5 Pin/70mm Keyed Alike Suits with 1141 Lock	Each	10	16129
	1145	Euro Cylinder - 5 Pin/60mm Keyed to Differ Suits with 1141 Lock	Each	10	16129
	1146	Economy Euro Cylinder - 5 Pin/60mm Keyed Alike. Suits 1141 Lock	Each	10	16129
	1149	Euro Cylinder - 5 Pin/Turn Key Alike Suits 1141 Lock	Each	10	16129
	1137	S/Steel Strike - Standard Suits 1141 Optimum Lock	Each	1	16129
	1138	S/Steel Extended Multifold Strike Suits 1141 Optimum Lock	Each	1	16101
	3000	Locking Bolt Guide (for Water Rated Door)	Bag	N/A	17311

# DOOR SECTION HARDWARE

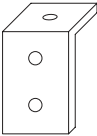
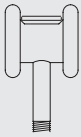
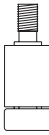
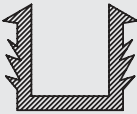
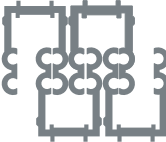
CODE	DESCRIPTION	U.O.M.	BOX QTY.	GROUP ID	
1810	Roller for Commercial Door Top Hung Max Weight 40kg To Suit TJ323	Pair	N/A	16149	
1809	Roller for Heavy Duty Commercial Door Top Hung Max Weight 80kg To Suit TJ365	Each	N/A	16149	
1811	Roller for Commercial Door Bottom Track Max Weight 50kg To Suit TJ361	Each	N/A	16149	
1824	Floor Guide Sliding Door	Each	N/A	16149	
1822	Roller Packer Suits 1800, 1801, 1802	Each	N/A	16149	
1813	Angle For Stacking Door Roller Fits with 1814/1815 to Suit TJ343	Each	N/A	16149	
1814	Roller for Stacking Door Track - 80KG Rated (Suit TJ343) Fits with 1813	Each	N/A	16149	
1815	Bottom Roller Guide Assembly Fits with 1813	Each	N/A	16149	
1612	Door Channel to Suit 6mm Glass Suits 35mm Door Sections (TJ380/381/382)	Roll	N/A	16169	
1816	Spigots for Commercial Doors Set of 4 with Bolts	Set	M/F	16169	



# DOOR SECTION HARDWARE

	CODE	DESCRIPTION	U.O.M.	BOX QTY.	GROUP ID
	1370**	Dow Corning 688 Silicone Glazing & Cladding Sealant  <i>688**Specify finish: Black-BL, Translucent-Trans, White-WH.</i>	Tube	24	16161
	1371**	Dow Corning 795 Structural Glazing Silicone  <i>795**Specify finish: Black-BL.</i>	Sausage	20	16161
	1311**	Dow Corning 680 Sanitary Silicone - Tube (Neutral Cure)  <i>680 **Specify Finish: Transparent-TR White-WH.</i>	Tube	20	16161
	1900-M	Frame Packers - 1.5mm x 90mm Blue 100/Bag	Bag	N/A	16157
	1901-M	Frame Packers - 3mm x 90mm Green 100/Bag	Bag	N/A	16157
	1902-M	Frame Packers - 5mm x 90mm Orchre 100/Bag	Bag	N/A	16157
	1903-M	Frame Packers - 10mm x 90mm Black 100/Bag	Bag	N/A	16157
	1910	Setting Blocks 3mm Thick	Bag	N/A	16157
	1911	Setting Blocks 5mm Thick	Bag	N/A	16157
	1912	Setting Blocks 10mm Thick	Bag	N/A	16157
	1930	End Cap To Suit Subsills Bag of 50 Pairs - Left + Right	Bag	N/A	16157
	1960	Lanotec General Purpose Liquid Lanolin 400g	Tube	12	16181
	1961	Lanotec "Citra Force" Cleaner Degreaser 400g	Tube	12	16181



Please check with your local branch for stock availability.

# SYSTEM TOOLING

## CODE DESCRIPTION

DTL3109-  
AIR 45mm Door Press  
Suits TJ154/155/158/159/321/322/327/311/312/313/315/  
HV271/273/281/289



## FRINGE PILE

CODE	DESCRIPTION	U.O.M.	BOX QTY.	GROUP ID	
2590	Fringe Pile Weatherstrip Strip 11mm x 600m Roll - Black	Roll	5	6146	
2600	Fringe Pile 13mm x 500m Roll - Black	Roll	5	6146	
2610	Fringe Pile 16mm x 500m Roll - Black	Roll	5	6146	
2620	Fringe Pile 28mm x 250m Roll - Black	Roll	5	6146	
1705	Weatherstrip 48-525 Black 500m Roll	Roll	5	16173	
1710	Weatherstrip 48-425 Black 550m Roll	Roll	5	16173	
1611	Weatherstrip 90-900 Black - 150m Roll	Roll	1	16173	

## RUBBERS / SEALS / FLAPS

CODE	DESCRIPTION	U.O.M.	BOX QTY.	GROUP ID	
1610- M100	6mm Door Stop - 100m Suits TJ306	Roll	1	16169	
1614	Door Stop Rubber - large 200m	Roll	1	16169	<b>NEW</b>
1754	Foam Seal QL48100 - 250m	Roll	N/A	16169	
1926	Drain Flap - 300m	Roll	N/A	16169	



 cityview

101.6mm LOUVRES

# MANUALLY OPERATED LOUVRE WINDOWS

## *EASY LIVING*

With louvres you can instantly adjust the amount of ventilation to suit your comfort. Enjoy refreshing breezes as well as keeping the elements out by incorporating our modern louvre system into your home.

- Beautiful
- Stylish
- Versatile

## *CREATIVE SOLUTIONS*

Make louvre windows an architectural feature of your home.

- Choose from a variety of glass, aluminium or timber glazing options.
- Choose from 102mm (4") or 152mm (6") blade size.



# MANUALLY OPERATED LOUVRE WINDOWS



## TECHNICAL DETAILS

**Design Rating:** Up to 450pa for water  
Up to 3000pa wind pressure

**Retaining Clip:** UV resistant PP/PE incorporating glazing relief slot.

**Handle 102mm (4"): 304 Grade Pressed Stainless Steel UV resistant PP/PE grip**

**Handle 152mm (6"): 6106 Grade Pressed Aluminium UV resistant PP/PE grip**

**Louvre Channel:** 6063 Extruded Aluminium

**Operator:** Aluminium control bar and stainless steel spin rivets.

**Glazing:** 6.38mm Laminated Glass  
6mm Toughened and Float Glass  
6mm Extruded Aluminium Blade  
14mm Extruded Aluminium Blade  
14mm Timber Blade

**Assembly:** Screws and hole plugs supplied with each gallery.

**Finishes:** Powder Coat - Black, White, White Birch  
Anodised - 20 micron Natural anodised.  
Special finishes available upon request

**Blade cutting formula:** = Daylight opening width -54mm

## 102MM (4") SIZE CHART

NO OF BLADES	CONTROL	BLADE SPLIT	HEIGHT (MM)
3	Single	3	292
4	Single	4	381
5	Single	5	470
6	Single	6	559
7	Single	7	648
8	Dual	4,4	737
9	Dual	4,5	826
10	Dual	5,5	915
11	Dual	5,6	1004
12	Dual	6,6	1093
13	Dual	6,7	1182
14	Dual	7,7	1271
15	Triple	5,5,5	1360
16	Triple	5,5,6	1449
17	Triple	5,6,6	1538
18	Triple	6,6,6	1627
19	Triple	6,6,7	1716
20	Triple	6,7,7	1805
21	Triple	7,7,7	1894
22	Quad	5,5,6,6	1983
23	Quad	5,5,6,7	2072
24	Quad	5,6,6,7	2161
25	Quad	6,6,6,7	2250
26	Quad	6,6,7,7	2339
27	Quad	6,7,7,7	2428

## 152MM (6") SIZE CHART

NO OF BLADES	CONTROL	BLADE SPLIT	HEIGHT (MM)
2	Single	2	305
3	Single	3	445
4	Single	4	585
5	Single	5	725
6	Dual	3,3	865
7	Dual	3,4	1005
8	Dual	4,4	1145
9	Dual	5,4	1285
10	Dual	5,5	1425
11	Triple	3,4,4	1565
12	Triple	4,4,4	1705
13	Triple	5,4,4	1845
14	Triple	5,5,4	1985
15	Triple	5,5,5	2125
16	Quad	4,4,4,4	2265
17	Quad	5,4,4,4	2405

## OPTIONS & ACCESSORIES

### Fixed Glass Extensions

Adjusts the opening height for non-standard size windows.

### Glazing Adaptors

For 14mm Timber or Extruded Aluminium Blades.

### Stacking Sleeve

Used for stacking Louvre Galleries on top of each other or attaching Fixed Glass Extensions.

### Remote Control Adaptors

Fits to existing handle operator. Allows remote control operation. No need to order a special handle.

### Map Hook Adaptors

Fits to existing handle operator. Allows manual operation in hard to reach applications.

### Timber Blades

14mm thick timber blades.

# MANUALLY OPERATED LOUVRE WINDOWS

## 152MM [6"] BLADE SIZE

CODE	NUMBER OF BLADES	CONTROL	GALLERY HEIGHT	FRAME HEIGHT
LV602	2	Single	305mm	400mm
LV603	3	Single	445mm	540mm
LV604	4	Single	585mm	680mm
LV605	5	Single	725mm	820mm
LV606	6	Dual	865mm	960mm
LV607	7	Dual	1005mm	1100mm
LV608	8	Dual	1145mm	1240mm
LV609	9	Dual	1285mm	1380mm
LV610	10	Dual	1425mm	1520mm
LV611	11	Triple	1565mm	1660mm
LV612	12	Triple	1705mm	1800mm
LV613	13	Triple	1845mm	1940mm
LV614	14	Triple	1985mm	2080mm
LV615	15	Triple	2125mm	2220mm
LV616	16	Quad	2265mm	2360mm
LV617	17	Quad	2405mm	2500mm
LV618	18	Quad	2545mm	2640mm
LV619	19	Quad	2685mm	2780mm

### Standard Finish:

Black powder coat - BL

Clear anodised 20um - CA

White powder coat - WH

White birch powder coat - WB



### Special Note:

Not all sizes / colours / configuration are available ex-stock.

## 102MM [4"] BLADE SIZE

CODE	NUMBER OF BLADES	CONTROL	GALLERY HEIGHT	FRAME HEIGHT
LV403	3	Single	292mm	387mm
LV404	4	Single	381mm	476mm
LV405	5	Single	470mm	565mm
LV406	6	Single	559mm	654mm
LV407	7	Single	648mm	743mm
LV408	8	Dual	737mm	832mm
LV409	9	Dual	826mm	921mm
LV410	10	Dual	915mm	1010mm
LV411	11	Dual	1004mm	1099mm
LV412	12	Dual	1093mm	1188mm
LV413	13	Dual	1182mm	1277mm
LV414	14	Dual	1271mm	1366mm
LV415	15	Triple	1360mm	1455mm
LV416	16	Triple	1449mm	1544mm
LV417	17	Triple	1538mm	1633mm
LV418	18	Triple	1627mm	1722mm
LV419	19	Triple	1716mm	1811mm
LV420	20	Triple	1805mm	1900mm
LV421	21	Triple	1894mm	1989mm
LV422	22	Quad	1983mm	2078mm
LV423	23	Quad	2072mm	2167mm
LV424	24	Quad	2161mm	2256mm
LV425	25	Quad	2250mm	2345mm
LV426	26	Quad	2339mm	2434mm
LV427	27	Quad	2428mm	2523mm
LV428	28	Quad	2517mm	2612mm
LV429	29	Quad	2606mm	2701mm

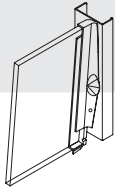
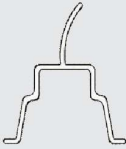
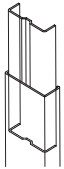
# MANUALLY OPERATED LOUVRE WINDOWS

	PART NO.	DESCRIPTION	PER	SPECIAL COLOUR
	LV9-601	Fixed Glass Extension - 152mm	Set	23.24
	LV9-401	Fixed Glass Extension - 102mm	Set	21.62
	LV9-501	Co-Extruded Seal - 3.0m To Suit Louvre Weather Bars(Black)	Each	N/A
	LV9-502	Stacking Sleeve	Pair	N/A
N/A	LV9-503	152mm x 6mm Louvre Clip	Pair	POA
N/A	LV9-504	102mm x 6mm Louvre Clip	Pair	POA
N/A	LV9-505	152mm x 14mm Louvre Clip	Pair	POA
N/A	LV9-506	102mm x 14mm Louvre Clip	Pair	POA
N/A	LV9-507	14mm Glazing Adaptor - 152mm	Pair	POA
N/A	LV9-508	14mm Glazing Adaptor - 102mm	Pair	POA
	LV9-509	Remote Control Adaptor	Each	N/A
	LV9-510	Map Hook Adaptor	Each	N/A
N/A	LV9-511	Torsion Bar Adaptor	Pair	N/A

# MANUALLY OPERATED LOUVRE WINDOWS

**PART NO. DESCRIPTION PER SPECIAL COLOUR**

LV9-527	Louvre Press Lock	Each	N/A	
---------	-------------------	------	-----	---

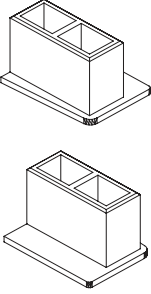
LV9-1834	Head and Sill Infill Block For Cityview Frame	20 per bag	Black	
----------	---	------------	-------	---

**Standard Finish:**

Black powder coat - BL      Clear anodised 20um - CA  
 White powder coat - WH      White birch powder coat - WB

**Special Note:**

- Minimum order quantities may apply.
- Not all sizes / colours / configuration are available ex-stock.
- Supplier surcharge may apply.







AutoLouve

# MOTORISED LOUVRE WINDOWS

AutoLouve™ **THE NEXT GENERATION**  
in motorised Louvre automation.

## Powerful concealed motor

AutoLouve™ is operated by a powerful linear motor that is directly connected to the Diamond Louvre gallery using our patented Radial Link®.

The Radial Link® combines the performance of the Diamond Louvre™ con-rod assembly with the power and reliability of the linear motor. AutoLouve™ delivers smooth, trouble free operation with maximum mechanical advantage.

The automation assembly is concealed inside the window jamb. The motor is accessed without removing glazing or the Louvre gallery via a removable panel.

## Advanced power and control

AutoLouve™ is powered by a safe easy to install low voltage power system. The motor, wiring and Radial Link® can be installed in the factory or onsite.

AutoLouve™ is compatible with commercially available CBUS and BMS automated building management systems, optimising environmental control and energy consumption.

AutoLouve™ is supplied standard with a fail safe circuit breaker.

Hand held remote controls are available in single and multi-channel frequencies.

## Insect screen

Insect and safety screens are installed from the inside of the Louvre frame, providing easy access for installation and cleaning.

Retractable insect screens can also be installed with the 102mm gallery providing increased air flow and the convenience of insect protection when required.

## Commercial framing compatible

AutoLouve™ couples directly to 101.6mm commercial shopfront systems. Frames can be installed using standard 100mm sub heads and sub sills. The system can be glazed using glass, aluminium or timber Louvre blades and can operate up to 27 blades from a single motor.

## Ready made

AutoLouve™ is conveniently supplied in pre-machined easy to assemble CKD kits.



# AutoLouve **MOTORISED LOUVRE WINDOWS**

## TECNICAL SPECIFICATIONS

### Diamond Louvre™ Specifications

#### Louvre Channel

6063 Extruded Aluminium

#### Finishes

Powder Coat: Black, White, White Birch  
 Anodised: 20 micron Natural anodised  
 Custom: Special channel finishes available upon request

#### Retaining Clip

102mm (4') UV resistant PP/PE  
 152mm (6") UV resistant PP/PE  
 6mm glass clip incorporating glazing relief slot  
 14mm clip for timber and Aluminium blades

#### Handles

152mm Louvre: 6106 Aluminium with ergonomic grip  
 102mm Louvre: 304 Stainless with ergonomic grip

#### Operator

Anodised Aluminium control & bar with cast bearing, stainless steel link bars & spin rivets

#### Blade cutting formula

Standard clip = daylight width - 54mm

#### Glazing

6mm-6.38mm Glass blades  
 6mm Aluminium blades  
 14mm Aluminium blades  
 14mm Western Red Cedar blades

#### Performance

20000 cycle test  
 Meets AS2047 windows in buildings

### AutoLouve™ Specifications

#### Drive Unit

12 volt DC Linear motor

#### Control Options

RF hand held remote control  
 Wall Mounted bell press switch (hard wired)  
 BMS compatible  
 CBUS compatible

#### Safety Options

Temperature Sensors  
 Smoke sensors  
 Rain Sensors  
 Battery Backup

#### Power Supply

4amp 12volt DC/240volt Transformer  
 Fail safe circuit breaker

#### Framing

120mm Aluminium perimeter frame  
 shopfront compatible

#### Blade cutting formula

Standard clip = daylight width - 144mm

#### Glazing

6mm-6.38mm Glass blades  
 6mm Aluminium blades  
 14mm Aluminium blades  
 14mm Western Red Cedar blades

#### Performance

20000 cycle test  
 Meets AS2047 windows in buildings

### 102mm (4")Size Chart

No of Blades	Control	Blade Split	Height (mm)	Frame Height
3	Single	3	292	342
4	Single	4	381	431
5	Single	5	470	520
6	Single	6	559	609
7	Single	7	648	698
8	Dual	4,4	737	787
9	Dual	4,5	826	876
10	Dual	5,5	915	965
11	Dual	5,6	1004	1054
12	Dual	6,6	1093	1143
13	Dual	6,7	1182	1232
14	Dual	7,7	1271	1321
15	Triple	5,5,5	1360	1410
16	Triple	5,5,6	1449	1499
17	Triple	5,6,6	1538	1588
18	Triple	6,6,6	1627	1677
19	Triple	6,6,7	1716	1766
20	Triple	6,7,7	1805	1855
21	Triple	7,7,7	1894	1944
22	Quad	5,5,6,6	1983	2033
23	Quad	5,5,6,7	2072	2122
24	Quad	5,6,6,7	2161	2211
25	Quad	6,6,6,7	2250	2300
26	Quad	6,6,7,7	2339	2389
27	Quad	6,7,7,7	2428	2478

### 152mm (6")Size Chart







No of Blades	Control	Blade Split	Height (mm)	Frame Height
2	Single	2	305	355
3	Single	3	445	495
4	Single	4	585	635
5	Single	5	725	775
6	Dual	3,3	865	915
7	Dual	3,4	1005	1055
8	Dual	4,4	1145	1195
9	Dual	5,4	1285	1335
10	Dual	5,5	1425	1475
11	Triple	3,4,4	1565	1615
12	Triple	4,4,4	1705	1755
13	Triple	5,4,4	1845	1895
14	Triple	5,5,4	1985	2035
15	Triple	5,5,5	2125	2175
16	Quad	4,4,4,4	2265	2315
17	Quad	5,4,4,4	2405	2455

# AutoLouve **MOTORISED LOUVRE WINDOWS**

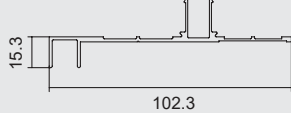
<b>PART NO.</b>	<b>DESCRIPTION</b>	<b>UNIT</b>
LA-PPK-12V	Powerpack 12 volt	Each
LA-RCT-SIN	Remote Control-Sgl Channel Transmitter	Each
LA-RCT-MUL	Remote Control-Multi Channel Transmitter	Each
LA-RCR-REC	Remote Receiver Unit	Each
LA-BPS-STD	Bell Press Switch-Lrg-Wht	Each
LA-BPS-SML	Bell Press Switch-Sml-Wht	Each

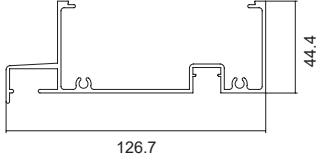

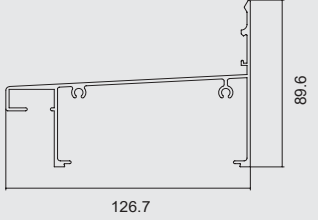
# CITYVIEW 101.6MM LOUVRE SYSTEM

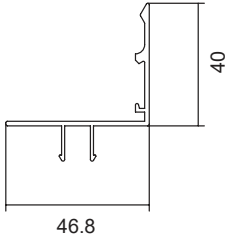
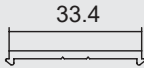
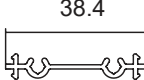
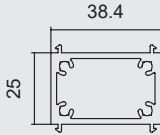
CODE	DESCRIPTION	LGTH.	FINISH	GROUP ID	
LVC001	Jamb Fits with TJ301	6.5m	M/F CL/ANOD	22301 22302	
LVC002	101.6mm Louvre Frame Head  1486  LV9-1834	6.5m	M/F CL/ANOD	22301 22302	
LVC003	101.6mm Louvre Frame Sill  1487  LV9-501, LV9-1834	6.5m	M/F CL/ANOD	22301 22302	
LVC005	Head Weather Bar Fits with LVC002  LV9-501	6.5m	M/F CL/ANOD	22301 22302	
LVC006	Jamb - Gallery Adaptor Fits with LCV001	3.0m	M/F CL/ANOD	22301 22302	
LVJ001	Gallery Joiner	6.5m	M/F CL/ANOD	22301 22302	
LVJ002	Box Gallery Joiner	6.5m	M/F CL/ANOD	22301 22302	

  Key hardware.

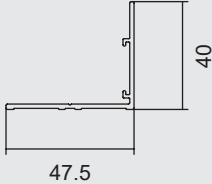
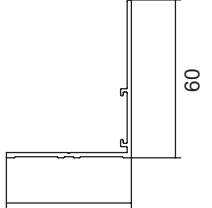
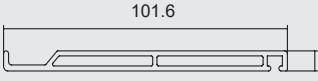
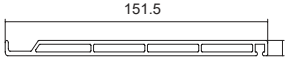
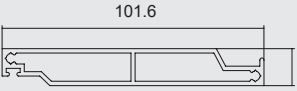
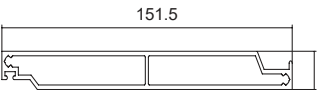

# CITYVIEW 101.6MM LOUVRE SYSTEM

	CODE	DESCRIPTION	LGTH.	FINISH	GROUP ID
	LVB040	40mm Weather Bar 🔑 LV9-501	3.0m	M/F CL/ANOD	22301 22302
			6.5M	M/F CL/ANOD	22301 22302
	LVB060	60mm Weather Bar 🔑 LV9-501	3.0m	M/F CL/ANOD	22301 22302
	LVB1026	102 x 6mm Blade	3.2m	M/F CL/ANOD	22301 22302
	LVB1526	152 x 6mm Blade	3.2m	M/F CL/ANOD	22301 22302
	LVB1013	102 x 13.5mm Blade	3.2m	M/F CL/ANOD	22301 22302
	LVB1513	152 x 13.5mm Blade	3.2m	M/F CL/ANOD	22301 22302

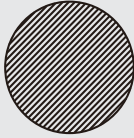
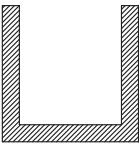
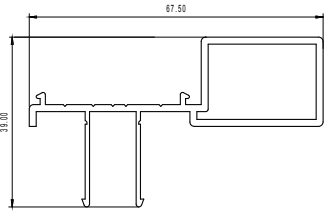
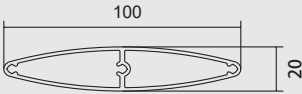

 Key hardware.

# CITYVIEW 101.6MM LOUVRE SYSTEM

	CODE	DESCRIPTION	LGTH.	FINISH	GROUP ID
	LVBB016	16mm Barrier Bar	4.0m	M/F CL/ANOD	22301 22302
	LVBC102	Barrier Channel Suits 102mm Blade Fits with LVBB016	4.3m	M/F CL/ANOD	22301 22302
	LVBC152	Barrier Channel Suits 152mm Blade Fits with LVBB016	4.3m	M/F CL/ANOD	22301 22302
	LVH1002	Security Bar Holder	6.5m	M/F CL/ANOD	22301 22302
	LVE100	Louvre 100 X 20 Recommended Max Span 1600mm  3100	6.5m 6.0m	M/F CL/ANOD	22901 22902
	3100	Oval End Cap To Suit LVE100 Fits into Louvre Gallery	60/ pack	BLACK GREY WHITE	16157



 Key hardware.

# RESIDENTIAL WINDOW & DOOR SYSTEMS



53mm & 76mm Sliding Window



53mm & 76mm  
Awning Window



53mm & 76mm  
Double Hung Window



53mm & 76mm  
Fixed Window



101.6mm Louvre  
Window



76mm French Door



101.6mm Sliding Door &  
165mm Sliding Stacking Door

The Klassicview™ Range of Residential Windows and Doors is the ideal choice for modern architectural requirements, meeting current design trends as well as performance specifications.

The Klassicview™ range is suitable for residential and semi-commercial buildings.

The Klassicview™ range consists of the following:

- 53mm & 76mm Sliding Window
- 53mm & 76mm Awning Window
- 53mm & 76mm Double Hung Window
- 101.6mm Louvre Window
- 53mm & 76mm Fixed Window
- 101.6mm Sliding Door & 165mm Sliding Stacking Door
- 76mm French Door
- Plus a range of adaptors to create a range of window and door combinations



The Klassicview™ windows and doors have been fully tested and passed the stringent requirements of AS 2047.

The KlassicView range are not listed in this catalogue. Please contact our sales team if you are interested in becoming a licensed fabricator.



# KLASSICVIEW™ & HARBOURVIEW™ KITS

Darley now provides Kits to fabricators.

- Including aluminium, hardware and seals/gaskets
- Aluminium cut to size and punched
- Ready to assemble

Please contact our technical support or sales team for further information.

- Sliding Door
- 53mm sliding Window
- 53mm Awning Window
- 53mm Double Hung Window
- 53mm Fixed Light
- 76mm Sliding Window
- 76mm Awning Window
- 76mm Double Hung
- 76mm Fixed Light

To place an order go to

<http://darleyaluminium.com.au/products/order-online>





